



User Guide

SM-PROFIBUS DP-V1

Solutions Module for:

- Unidrive SP
- Commander SK
- Affinity
- Digitax ST
- Mentor MP

Part Number: 0471-0008-10

Issue Number: 10

General Information

The manufacturer accepts no liability for any consequences resulting from inappropriate, negligent or incorrect installation or adjustment of the optional parameters of the equipment or from mismatching the variable speed drive with the motor.

The contents of this guide are believed to be correct at the time of printing. In the interests of commitment to a policy of continuous development and improvement, the manufacturer reserves the right to change the specification of the product or its performance, or the content of the guide without notice.

All rights reserved. No parts of this guide may be reproduced or transmitted in any form or by any means, electrical or mechanical including, photocopying, recording or by an information storage or retrieval system, without permission in writing from the publisher.

Environmental Statement

Control Techniques is committed to minimising the environmental impacts of its manufacturing operations and of its products throughout their life cycle. To this end, we operate an Environmental Management System (EMS) which is certified to the International Standard ISO 14001. Further information on the EMS, our Environment Policy and other relevant information is available on request, or can be found at www.greendrives.com.

The electronic variable speed drives manufactured by Control Techniques have the potential to save energy and (through increased machine/process efficiency) reduce raw material consumption and scrap throughout their long working lifetime. In typical applications, these positive environmental effects far outweigh the negative impacts of product manufacture and end-of-life disposal.

Nevertheless, when the products eventually reach the end of their useful life, they must not be discarded but should instead be recycled by a specialist recycler of electronic equipment. Recyclers will find the products easy to dismantle into their major component parts for efficient recycling. Many parts snap together and can be separated without the use of tools, while other parts are secured with conventional fasteners. Virtually all parts of the product are suitable for recycling.

Product packaging is of good quality and can be re-used. Large products are packed in wooden crates, while smaller products come in strong cardboard cartons which themselves have a high-recycled fibre content. If not re-used, these containers can be recycled. Polythene, used on the protective film and bags from wrapping product, can be recycled in the same way. Control Techniques' packaging strategy prefers easily recyclable materials of low environmental impact, and regular reviews identify opportunities for improvement.

When preparing to recycle or dispose of any product or packaging, please observe local legislation and best practice.

Software Statement

This Solutions Module (SM) is supplied with the latest software version. When retro-fitting to an existing system, all software versions should be verified to confirm the same functionality as Solutions Modules of the same type already present. This also applies to products returned from a Control Techniques Service Centre or Repair Centre. If there is any doubt please contact the supplier of the product.

The software version of the Solutions Module can be identified by looking at Pr **MM.02** and Pr **MM.51**, where **MM** is the relevant menu number for the Solutions Module slot being used.

See Pr **MM.02** and Pr **MM.51** description later in this manual for more information.

The software version takes the form of xx.yy.zz, where Pr **MM.02** displays xx.yy and Pr **MM.51** displays zz (e.g. for software version 01.01.00 Pr **MM.02** will display 1.01 and Pr **MM.51** will display 0).

REACH legislation

EC Regulation 1907/2006 on the Registration, Evaluation, Authorisation and restriction of Chemicals (REACH) requires the supplier of an article to inform the recipient if it contains more than a specified proportion of any substance which is considered by the European Chemicals Agency (ECHA) to be a Substance of Very High Concern (SVHC) and is therefore listed by them as a candidate for compulsory authorisation.

For current information on how this requirement applies in relation to specific Control Techniques products, please approach your usual contact in the first instance. Control Techniques position statement can be viewed at:

<http://www.controltechniques.com/REACH>

Contents

1	Safety information	6
1.1	Warnings, Cautions and Notes	6
1.2	Electrical safety - general warning	6
1.3	System design and safety of personnel	6
1.4	Environmental limits	7
1.5	Compliance with regulations	7
1.6	Motor	7
1.7	Adjusting parameters	7
2	Introduction	8
2.1	What is PROFIBUS-DP?	8
2.2	What is SM-PROFIBUS DP-V1?	10
2.3	General specification	10
2.4	Solutions Module identification	11
3	Mechanical installation	12
3.1	General Installation	12
4	Electrical installation	13
4.1	Terminal descriptions	13
4.2	PROFIBUS-DP connectors	13
4.3	PROFIBUS-DP cable	14
4.4	Cable shielding	14
4.5	General grounding considerations	14
4.6	Network termination	14
4.7	Maximum network length / device loading	15
4.8	Node addressing	15
4.9	Spurs	15
4.10	Minimum node to node cable length	15
5	Getting started	16
5.1	Conventions used in this guide	16
5.2	Minimum software versions required	16
5.3	Set-up flow chart	17
5.4	Node address	18
5.5	Network data rate	18
5.6	Data format	19
5.7	Network operating status	19
5.8	Re-initializing the SM-PROFIBUS DP-V1	20
5.9	Re-initialize all Solutions Modules	20
5.10	Saving parameters to the drive	20
5.11	Network compatibility mode	21
6	GSD Files	23
6.1	What are GSD Files?	23
6.2	Data consistency	23
6.3	Data configuration	24
6.4	GSD compatibility	24
6.5	GSD compatibility flowchart	25

7	Cyclic data	26
7.1	What is cyclic data?	26
7.2	Data formats	26
7.3	Mapping conflicts	29
7.4	Cyclic data mapping errors	29
7.5	Mapping limitations	30
7.6	Disabling mappings	30
8	Non-cyclic data	31
8.1	What is non-cyclic data?	31
8.2	Configuration using non-cyclic data	31
8.3	PROFIBUS DP-V1 Compatibility	31
8.4	PROFIBUS DP-V1 Overview	32
8.5	Setting the non-cyclic mode (non-cyclic over cyclic)	33
8.6	Mode 1 - CT Single Word mode	34
8.7	Reading parameters using CT Single Word	36
8.8	Mode 2 - PPO 4 Word mode	44
9	Control and status words	51
9.1	What are control and status words?	51
9.2	Control word	51
9.3	Status word	53
10	Diagnostics	55
10.1	Module ID code	55
10.2	Module firmware version	55
10.3	PROFIBUS-DP node address	56
10.4	Network data rate	56
10.5	Data format	57
10.6	Operating status	57
10.7	Mapping status	58
10.8	Drive trip display codes	60
10.9	Module error code	60
10.10	Module serial number	61
10.11	Troubleshooting	61
11	PROFIdrive profile (V4)	63
11.1	What is PROFIdrive profile?	63
11.2	Standard Telegram 1	63
11.3	Main Setpoint	64
11.4	Main Actual Value	65
11.5	PROFIdrive (V4) State Machine	66
11.6	Normal Run Sequence	66
11.7	Stopping the motor using PROFIdrive	69
11.8	Jogging	69
11.9	PROFIdrive control word	70
11.10	PROFIdrive status word	71
11.11	PROFIdrive PNU access	72
11.12	Fault Buffer	73
11.13	Drive Identification	74
11.14	Identification and Maintenance Functions	74

12	Advanced features	75
12.1	Network loss trip	75
12.2	SYNC and FREEZE Mode	76
12.3	Data endian format	76
12.4	Inter-option communication timing	77
12.5	Cyclic data compression	77
12.6	Block mapping	78
12.7	Direct data mapping	80
12.8	Custom data formats	81
12.9	Restore defaults	82
12.10	Storing SM-PROFIBUS DP-V1 parameters (backup)	82
12.11	Restore previous SM-PROFIBUS DP-V1 configuration	83
12.12	Menu 60 - Local Solutions access	84
12.13	Mapping to SM-Applications parameters	84
12.14	EVENT task trigger in SM-Applications	85
12.15	Multi-master operation	86
13	Legacy features	87
13.1	Network compatibility mode	87
13.2	PPO Types	88
13.3	Configuring the Profile	89
13.4	PROFIdrive control word	90
13.5	PROFIdrive status word	91
13.6	Main Setpoint	92
13.7	Main Actual Value	92
13.8	PROFIdrive (V2) state machine diagram	93
14	Quick reference	96
14.1	Complete parameter reference	96
14.2	Operating status codes	98
14.3	Mapping error codes	98
14.4	Error codes	100
15	Glossary of terms	101
	Index	104

1 Safety information

1.1 Warnings, Cautions and Notes



A **Warning** contains information, which is essential for avoiding a safety hazard.



A **Caution** contains information, which is necessary for avoiding a risk of damage to the product or other equipment.

NOTE

A **Note** contains information, which helps to ensure correct operation of the product.

1.2 Electrical safety - general warning

The voltages used in the drive can cause severe electrical shock and/or burns, and could be lethal. Extreme care is necessary at all times when working with or adjacent to the drive.

Specific warnings are given at the relevant places in this User Guide.

1.3 System design and safety of personnel

The drive is intended as a component for professional incorporation into complete equipment or a system. If installed incorrectly, the drive may present a safety hazard.

The drive uses high voltages and currents, carries a high level of stored electrical energy, and is used to control equipment which can cause injury.

Close attention is required to the electrical installation and the system design to avoid hazards either in normal operation or in the event of equipment malfunction. System design, installation, Commissioning/start-up and maintenance must be carried out by personnel who have the necessary training and experience. They must read this safety information and this User Guide carefully.

None of the drive functions isolate dangerous voltages from the output of the drive or from any external option unit. The supply must be disconnected by an approved electrical isolation device before gaining access to the electrical connections.

With the sole exception of the SAFE TORQUE OFF (SECURE DISABLE) function on Unidrive SP and Digitax ST, none of the drive functions must be used to ensure safety of personnel, i.e. they must not be used for safety-related functions.

The SAFE TORQUE OFF (SECURE DISABLE) function is only available on Unidrive SP and Digitax ST. The Commander SK, Affinity and Mentor MP drives do not have either of these features.

Careful consideration must be given to the functions of the drive which might result in a hazard, either through their intended behavior or through incorrect operation due to a fault. In any application where a malfunction of the drive or its control system could lead to or allow damage, loss or injury, a risk analysis must be carried out, and where necessary, further measures taken to reduce the risk - for example, a fail-safe mechanical brake in case of loss of motor braking.

The SAFE TORQUE OFF function has been approved by BGIA as meeting the requirements of the following standards, for the prevention of unexpected starting of the drive:

EN 61800-5-2:2007	SIL 3
EN ISO 13849-1:2006	PL e
EN 954-1:1997	Category 3

The SAFE TORQUE OFF function may be used in a safety-related application.

The system designer is responsible for ensuring that the complete system is safe and designed correctly according to the relevant safety standards.

1.4 Environmental limits

Instructions regarding transport, storage, installation and use of the drive must be complied with, including the specified environmental limits. These instructions can be found in the relevant drive documentation. Drives must not be subjected to excessive physical force.

1.5 Compliance with regulations

The installer is responsible for complying with all relevant regulations, such as national wiring regulations, accident prevention regulations and electromagnetic compatibility (EMC) regulations. Particular attention must be given to the cross-sectional areas of conductors, the selection of fuses or other protection, and protective ground (earth) connections.

Instructions for achieving compliance with specific EMC standards may be found in the relevant drive documentation.

Within the European Union, all machinery in which this product is used must comply with the following directives:

- 2006/42/EC: Safety of machinery.
- 2004/108/EC: Electromagnetic Compatibility.

1.6 Motor

Ensure the motor is installed in accordance with the manufacturer's recommendations. Ensure the motor shaft is not exposed.

Standard squirrel cage induction motors are designed for single speed operation. If it is intended to use the capability of the drive to run a motor at speeds above its designed maximum, it is strongly recommended that the manufacturer is consulted first.

Low speeds may cause the motor to overheat because the cooling fan becomes less effective. The motor should be installed with a protection thermistor. If necessary, an electric forced vent fan should be used.

The values of the motor parameters set in the drive affect the protection of the motor. The default values in the drive should not be relied upon.

It is essential that the correct value is entered in the motor rated current parameter: This affects the thermal protection of the motor.

1.7 Adjusting parameters

Some parameters have a profound effect on the operation of the drive. They must not be altered without careful consideration of the impact on the controlled system.

Measures must be taken to prevent unwanted changes due to error or tampering.

2 Introduction

2.1 What is PROFIBUS-DP?

PROFIBUS-DP (Decentralized Peripheral) is a networking system that falls into the generic category of fieldbus. Fieldbuses are generally defined as industrial networking systems that are intended to replace traditional wiring systems. Figure 2-1 shows the traditional cabling requirements to transfer signals between 2 slaves and a master.

Figure 2-1 Traditional cable layout

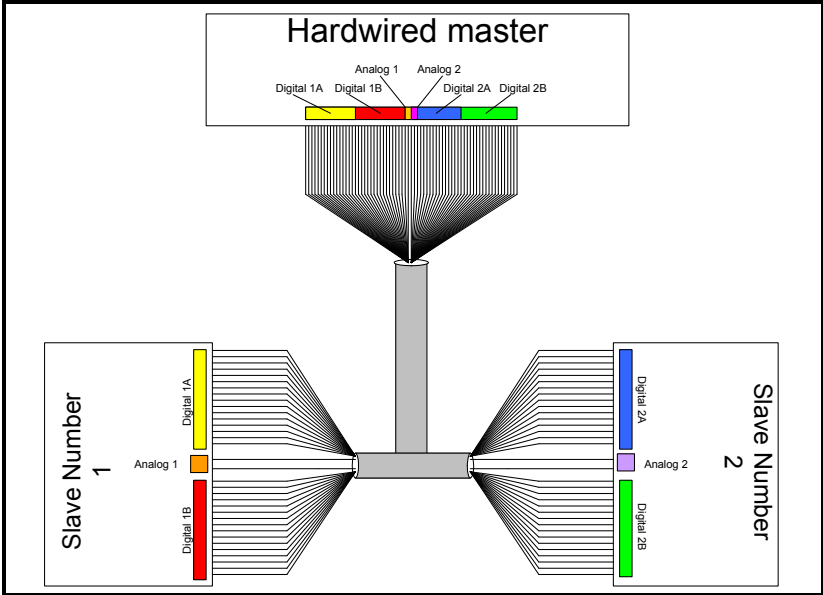

Table 2.1 details how the wiring is used to communicate data between the master and the slaves. Each signal that is communicated requires one signal wire giving a total of 66 signal wires plus a 0V return.

Table 2.1 Traditional wiring details

Number of signals	Type	Source / Destination	Description
16	digital Inputs	slave 1 to master	status signals
16	digital outputs	master to slave 1	control signals
1	analog output	master to slave 1	control signal
16	digital inputs	slave 2 to master	status signals
16	digital outputs	master to slave 2	control signals
1	analog output	master to slave 2	control signal

A fieldbus topology such as PROFIBUS-DP allows the same configuration to be realized using only two signal wires plus a shield. This method of communication saves significantly on the amount of cabling required and can improve overall system reliability as the number of interconnections is greatly reduced.

Figure 2-2 shows a typical PROFIBUS-DP network system transferring the same signals as given in the traditionally wired example. The signals are now transmitted by converting them into a serial data stream which is received by the master as if they were connected using traditional wiring. The data stream on SM-PROFIBUS DP-V1 allows up to 64 (32 input and 32 output) independent values to be sent or received by the master, in addition to a single channel allowing for random access to drive parameters.

Figure 2-2 PROFIBUS-DP cable layout

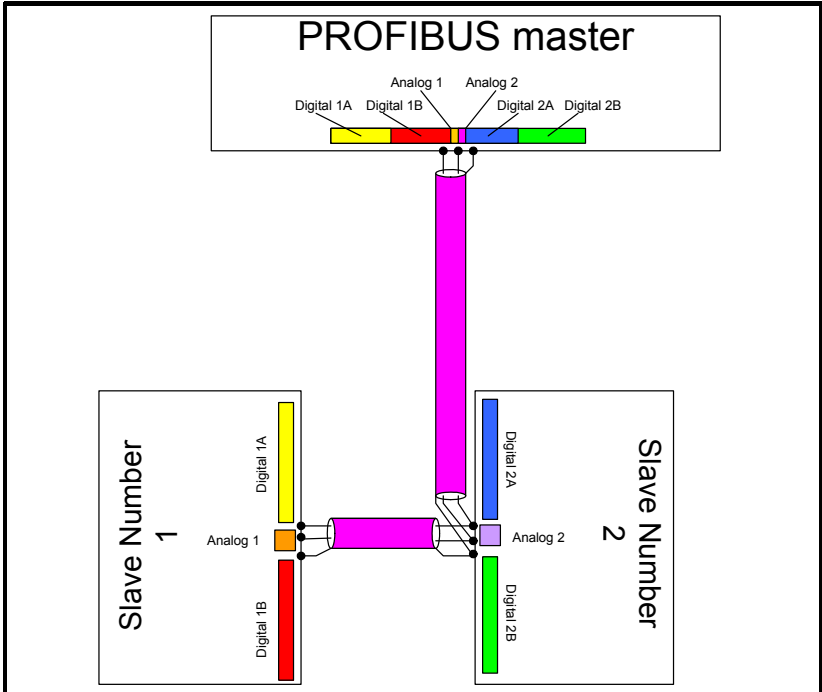

Table 2.2 Data mappings for SM-PROFIBUS DP-V1

Number of network words	Type	Source / Destination	Description
1	digital Inputs	slave 1 to master	status signals
1	digital outputs	master to slave 1	control signals
1	analog output	master to slave 1	control signal
1	digital inputs	slave 2 to master	status signals
1	digital outputs	master to slave 2	control signals
1	analog output	master to slave 2	control signal

Table 2.2 details the number of data words used to communicate the signals using the PROFIBUS-DP network. It can be seen that the resulting reduction in cabling is significant.

PROFIBUS-DP can transfer data using two distinct modes. The first of these modes is cyclic where signals are sent in predefined blocks at regular intervals. This is the equivalent of the hard-wired example in Figure 2-1.

The second method of transfer is called non-cyclic data and is used for sending values that only need to be changed occasionally or where the source or destination of the signal changes. This is the equivalent of a temporary patch lead that is removed after use.

2.2 What is SM-PROFIBUS DP-V1?

The SM-PROFIBUS DP-V1 is a fieldbus Solutions Module that can be installed to the expansion slot(s) in any of the following drives to provide PROFIBUS-DP slave connectivity:

- Unidrive SP
- Commander SK
- Affinity
- Digitax ST
- Mentor MP

With the exception of the Commander SK drive, it is possible to use more than one SM-PROFIBUS DP-V1 or a combination of SM-PROFIBUS DP-V1 and other Solution Modules to add additional functionality such as extended I/O, gateway functionality, or additional PLC features.

Figure 2-3 SM-PROFIBUS DP-V1

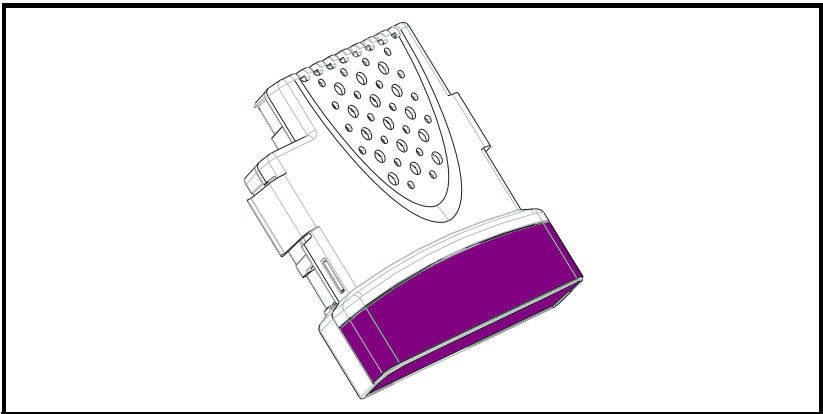

2.3 General specification

2.3.1 Features

The following section gives a brief overview of the functionality available within SM-PROFIBUS DP-V1.

- Supported data rates (bits/s): 12M, 6.0M, 3.0M, 1.5M, 500k, 187.5k, 93.75k, 45.45k, 19.2k, 9.6k.
- Maximum of 32 input and 32 output cyclic data words supported
- PROFIdrive profiles (V2 and V4) supported
- Non-cyclic data channel supported
- Parallel acyclic/cyclic data communication

The SM-PROFIBUS DP-V1 is powered from the host drive's internal power supply.

2.3.2 Main differences between DP-V0 and DP-V1

The main differences between DP-V0 and DP-V1 supported by SM-PROFIBUS DP-V1 are:

- PROFIdrive profile V4 support, which consists of
 - Standard Telegram 1
 - PROFIdrive PNU Access
 - Drive Identification
 - Fault Buffer
 - Identification and Maintenance Functions
- Non-cyclic data channel access

2.4 Solutions Module identification

The SM-PROFIBUS DP-V1 can be identified by:

1. The label located on the underside of the Solutions Module.
2. The color coding across the front of the SM-PROFIBUS DP-V1 (purple).

Figure 2-4 SM-PROFIBUS DP-V1 labels

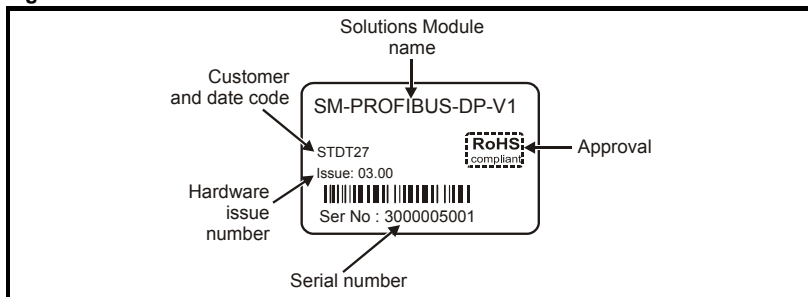

2.4.1 Date code format

The date code is split into two sections: a letter followed by a number.

The letter indicates the year, and the number indicates the week number (within the year) in which the Solutions Module was built.

The letters go in alphabetical order, starting with A in 1991 (B in 1992, C in 1993 etc.).

Example:

A date code of T27 would correspond to week 27 of year 2010.

2.4.2 Unidrive SP, Digitax ST, Affinity and Mentor MP

The required drive can be connected to a 24Vdc back-up power supply (terminals 1 and 2). This keeps the control electronics and Solutions Module powered up, allowing the SM-PROFIBUS DP-V1 to continue communicating with the PROFIBUS-DP master controller when the main supply to the drive is switched off. For every SM-PROFIBUS DP-V1 installed allow for an extra 70mA of supply current to be drawn from the back-up supply.

NOTE This feature is only available on the Unidrive SP, Digitax ST, Affinity and Mentor MP.

3 Mechanical installation



Before installing or removing a Solutions Module in any drive, ensure the AC supply has been disconnected for at least 10 minutes and refer to Chapter 1 *Safety information* on page 6. If using a DC bus supply ensure this is fully discharged before working on any drive or Solutions Module.

3.1 General Installation

The installation of a Solutions Module is illustrated in Figure 3-1.

Figure 3-1 Installing a Solutions Module

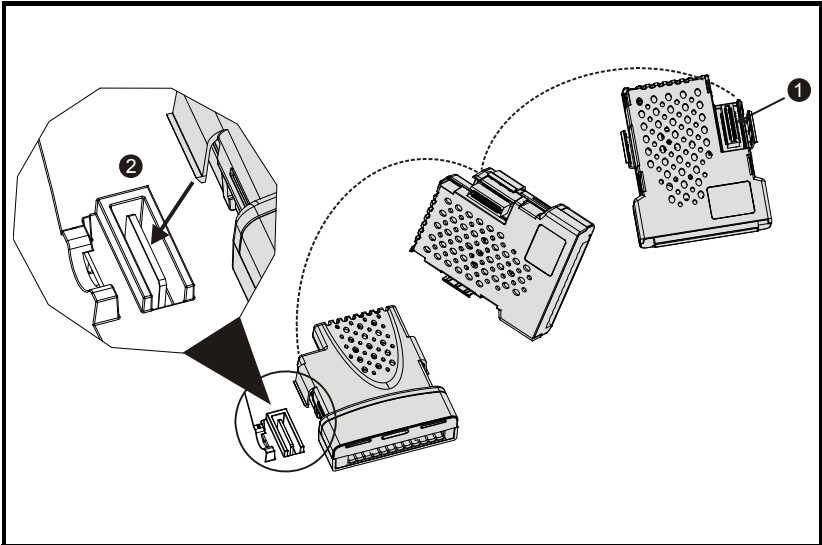

The Solutions Module connector is located on the underside of the module (1). Push this into the Solutions Module slot located on the drive until it clicks into place (2). Note that some drives require a protective tab to be removed from the Solutions Module slot. For further information, refer to the appropriate drive documentation.

4 Electrical installation

4.1 Terminal descriptions

The SM-PROFIBUS DP-V1 has a standard 9-way female D-type connector for the PROFIBUS-DP network.

Figure 4-1 SM-PROFIBUS DP-V1 terminals

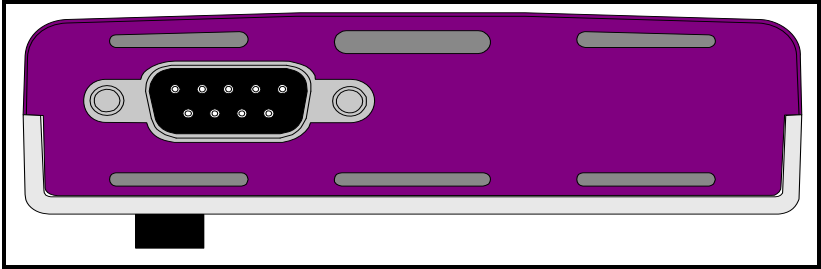

Figure 4-2 SM-PROFIBUS DP-V1 D-Type pin out

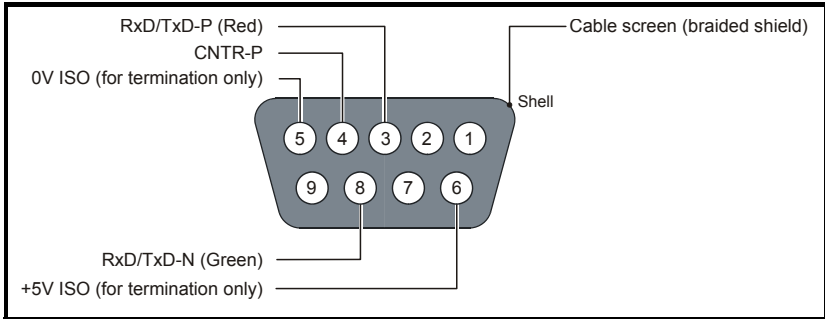

Table 4.1 D-Type connections

D-type Terminal	Function	Description
3	RxD/TxD-P	Positive data line (B) - Red
8	RxD/TxD-N	Negative data line (A) - Green
6	+5V ISO	+5V isolated, use only for termination resistors
5	0V ISO	0V isolated, use only for termination resistors
4	CNTR-P	RTS line
1, Shell	Shield	Cable shield connection

Control Techniques recommend using connectors approved by Profibus International at all times.

4.2 PROFIBUS-DP connectors

There are many manufacturers of PROFIBUS-DP connectors. Always ensure that any connectors used on the network are fully approved for use with PROFIBUS-DP. Some of the connector types available include built in termination that allows the network to be isolated, this can be very useful when fault finding. For data rates above 1.5Mbps connectors installed with integrated inductors should be used.

4.3 PROFIBUS-DP cable

PROFIBUS-DP networks can run at high data rates and require cable specifically designed to carry high frequency signals. Low quality cable will attenuate the signals, and may render the signal unreadable for the other nodes on the network. Cable specifications and a list of approved manufacturers of cable for use on PROFIBUS-DP networks are available on the PROFIBUS Nutzerorganisation (PNO) web site at www.profibus.com.

NOTE Control Techniques can only guarantee correct and reliable operation of the SM-PROFIBUS DP-V1 if all other equipment on the PROFIBUS-DP network (including the network cable) has been approved by the PNO and is correctly installed.

4.4 Cable shielding

Correct shielding of the PROFIBUS-DP cable is required for reliable operation at high data rates, this can be achieved by exposing the cable shield of each PROFIBUS-DP cable and ensuring that they are clamped to the drive grounding metalwork as close as possible to the drive termination, contact your supplier or local Control Techniques Drive Centre for more information.

NOTE Unless there are specific reasons for not grounding the network it is recommended that all drive network connections are correctly grounded. Failure to do so may reduce the noise immunity of the system. If there are specific issues with grounding, alternative methods of connection should be considered such as the use of fibre optic cable.

4.5 General grounding considerations

It is essential that good grounding is provided not only for network stability but more importantly electrical safety. In all instances electrical regulations should be adhered to. As a guide the network cable should be grounded at least once per cabinet, ideally on each drive.

4.6 Network termination

It is very important in high-speed communications networks that the network communications cable is installed with the specified termination resistor network at each end of each segment. This prevents signals from being reflected back down the cable and causing interference.

Most ranges of connectors provide specific parts that incorporate the termination network. Such connectors derive the power from the host device and if the host device is switched off the termination will be lost. To avoid this situation a separate termination device is available that is powered independently of the network devices. For more information go to www.profibus.com.

NOTE Failure to terminate a network correctly can seriously affect the operation of the network. If the correct termination networks are not installed, the noise immunity of the network is greatly reduced. Each network segment must be correctly terminated.

4.7 Maximum network length / device loading

The maximum number of devices that can be connected to a single PROFIBUS-DP network segment is 32, this includes all nodes and any repeaters. The maximum lengths of cable for a segment depend on the data rate and are shown in Table 4.2.

Repeaters or fiber optic segments can be used to extend the network, allowing more than 32 nodes to be connected on the network. The maximum number of nodes on a single network is 125.

NOTE For full details on designing and installing a PROFIBUS-DP network, refer to *Installation Guidelines for PROFIBUS-DP/FMS*. This document is available from the PROFIBUS web site at www.profibus.com.

Table 4.2 PROFIBUS-DP maximum network lengths

Data rate (bits/s)	Maximum trunk length (m)
12M	100
6.0M	100
3.0M	100
1.5M	200
500k	400
187.5k	1000
93.75k	1200
45.45k	1200
19.2k	1200
9.6K	1200

4.8 Node addressing

SM-PROFIBUS DP-V1 has a valid address range of 1 to 125. Addresses 126 and 0 are reserved for system use and should not be used. The addressing scheme used is at the discretion of the end user however it is recommended that nodes are numbered in order as they appear on the physical network. It is not necessary to use consecutive numbers and gaps in the addressing scheme may be left to allow for future expansion.

4.9 Spurs

The PROFIBUS-DP specification allows spurs at data rates less than 1.5Mbits/s. At data rates below 1.5Mbits/s there are specific requirements for capacitance and length of cable allowed when using spurs. Control Techniques recommend that spurs are not used as extreme care is required at the design stage to avoid network problems. More information on spurs can be found on the PROFIBUS web site at www.profibus.com.

4.10 Minimum node to node cable length

The minimum recommended node to node distance is one metre of network cable. This distance is necessary to avoid multiple nodes generating a single large reflection on the network, using less than one metre of cable between nodes can have serious implications for network reliability.

5 Getting started

This section is intended to provide a generic guide for setting up SM-PROFIBUS DP-V1 and a master controller. Figure 5-1 is intended as a guide only and is provided to detail the stages that are required to achieve a functioning network. It is recommended that all of this chapter is read, before attempting to configure a system.

NOTE Due to the large number of PLCs/masters that support PROFIBUS-DP only generic details can be provided. Support is available through your supplier or local Control Techniques Drive Centre.

NOTE Before contacting your supplier or local Control Techniques Drive Centre for support ensure you have read Chapter 10 *Diagnostics* on page 55 of this manual and check you have configured all parameters correctly.

Ensure the following information is available before calling:

- A list of all parameters in SM-PROFIBUS DP-V1.
- The drive firmware version (*see the relevant drive user guide*).
- The SM-Profibus DP-V1 firmware version.

5.1 Conventions used in this guide

The configuration of the host drive and Solutions Module is done using menus and parameters. A menu is a logical collection of parameters that have similar functionality. In the case of a Solutions Module, the parameters will appear in menu 15 for the Commander SK, and in menu 15, 16, or 17 for the Unidrive SP, Affinity, Mentor MP and Digitax ST depending on the slot the module is installed in.

The menu is determined by the number before the decimal point and the parameter by the number following the decimal point.

The method used to determine the menu or parameter is as follows:

- Pr **MM.xx** - Menu corresponding to the Solution Module and any parameter.
- Pr **xx.00** - signifies parameter number 00 in any menu.

5.2 Minimum software versions required

Table 5.1 Minimum software versions required for use with SM-PROFIBUS

Product	Software Version	SM-PROFIBUS Version
Unidrive SP	V01.06.00 or later	V01.00.00 or later
Affinity	V01.00.00 or later	V03.00.00 or later
Digitax ST	V01.00.00 or later	V03.00.00 or later
Commander SK	V01.06.00 or later	V03.00.00 or later
Mentor MP	V01.02.00 or later	V03.02.00 or later

5.3

Set-up flow chart

Figure 5-1 Set-up flow chart

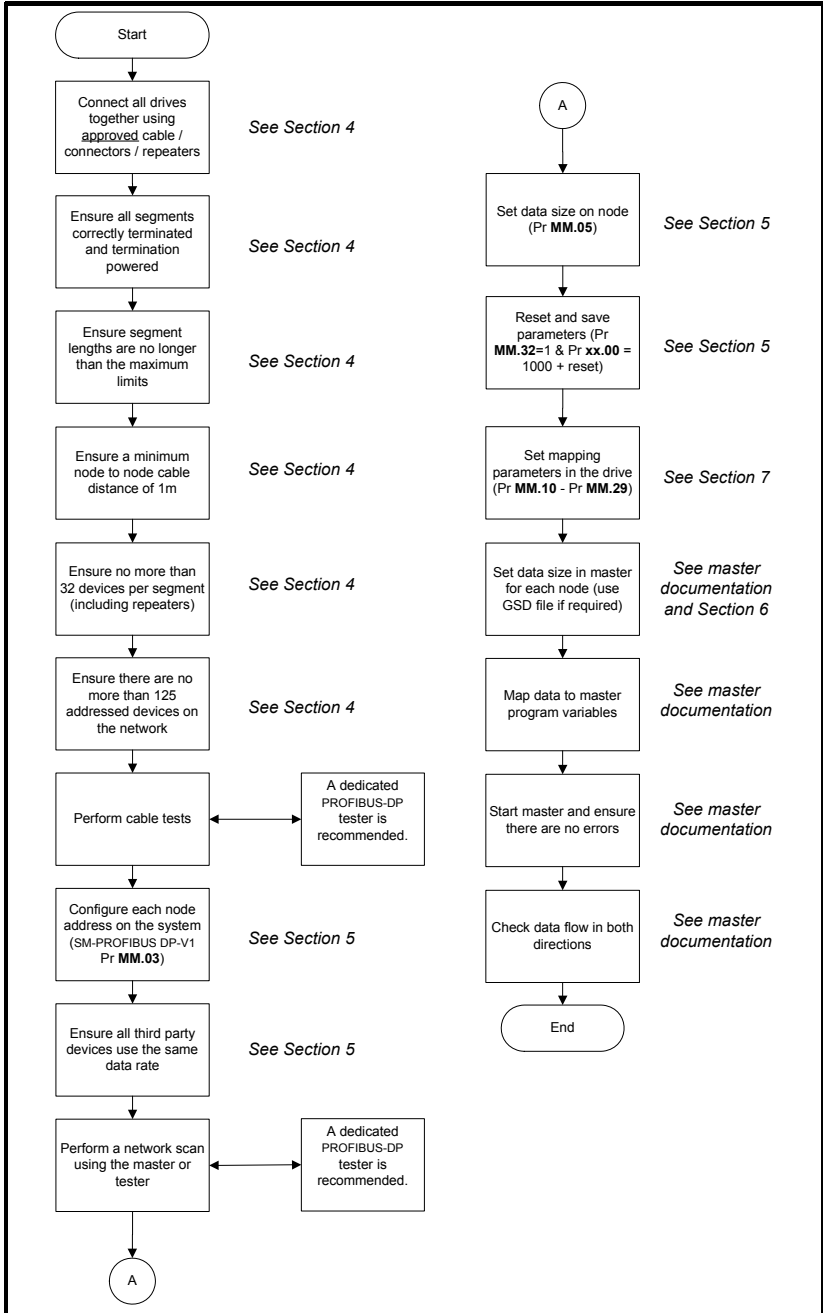

Safety information
Introduction
Installation
Mechanical installation
Electrical installation
Getting started
GSD files
Cyclic data
Non-cyclic data
Control and status words
Diagnostics
PROFIBUS profile (V4)
Advanced features
Legacy features
Quick reference
Glossary of terms
Index

5.4 Node address

Table 5.2 PROFIBUS-DP node address

Pr MM.03	Default	126
	Range	0 to 126
	Access	RW

Every node on a PROFIBUS-DP network must be given a unique network node address. To activate a change in the node address value the SM-PROFIBUS DP-V1 must be re-initialized (Pr **MM.32** = ON). This parameter is also available in menu 0 on the Commander SK (Pr **00.52**). Addresses 0 and 126 are reserved for system use.

5.5 Network data rate

Table 5.3 PROFIBUS-DP data rate

Pr MM.04	Default	N/A
	Range	-1 to 9
	Access	RO

The SM-PROFIBUS DP-V1 will automatically detect the PROFIBUS-DP network data rate and synchronize to it. Pr **MM.04** will indicate the data rate that has been detected by the SM-PROFIBUS DP-V1. This parameter is also available in menu 0 on the Commander SK (Pr **00.53**).

A value of -1 indicates that the SM-PROFIBUS DP-V1 has not detected any activity on the PROFIBUS-DP network, and is waiting for the master controller to start communicating.

NOTE The PROFIBUS-DP data rate parameter can be changed, but this will not affect the data rate at which the SM-PROFIBUS DP-V1 communicates. The data rate display will be updated when SM-PROFIBUS DP-V1 is re-initialized.

Table 5.4 Network data rate status

Pr MM.04	bits/s
-1	Auto-detecting
0	12M
1	6.0M
2	3.0M
3	1.5M
4	500k
5	187.5k
6	93.75k
7	45.45k
8	19.2k
9	9.6k

5.6 Data format

Table 5.5 PROFIBUS-DP data format

Pr MM.05	Default	4
	Ranges	0 to 32,100 to 131, 200 to 228
	Access	RW

The default data format is four cyclic words, each cyclic data channel is mapped to a drive parameter. The default mappings are shown in Table 5.6.

NOTE The maximum number of 16-bit data words that is possible is 32 with only cyclic data, 31 with Mode 1 non-cyclic data and 28 with PPO4 word mode.

Table 5.6 Default data mapping

Cyclic word	Data word	Default mapping status
IN channel 0	word 0, 1	Pr 10.40 , status word
IN channel 1	word 2, 3	Pr 2.01 , post-ramp speed reference
OUT channel 0	word 0, 1	Pr 6.42 , control word
OUT channel 1	word 2, 3	Pr 1.21 , digital speed reference 1

Other data formats are also supported. For further details see section 7.2 *Data formats* on page 26. The directions specified in Table 5.6 relate to the data direction as seen by the master.

5.7 Network operating status

Table 5.7 Network operating status

Pr MM.06	Default	N/A
	Range	-3 to 9999
	Access	RO

The PROFIBUS-DP network activity can be monitored in the SM-PROFIBUS DP-V1 operating status parameter, Pr **MM.06**. When the SM-PROFIBUS DP-V1 is communicating successfully with the PROFIBUS-DP master controller, Pr **MM.06** will give an indication of the number of cyclic data messages that are being processed per second. This parameter is also available in menu 0 on the Commander SK (Pr **00.54**).

Table 5.8 Network operating status codes

Pr MM.06	Parameter	Description
>0	Network ok	Indicates the number of processed cyclic messages per second.
0	Network ok, no data transfer	Indicates that the PROFIBUS-DP master has established communications with the SM-PROFIBUS DP-V1. If operating status changes briefly to -1 and returns to 0, the slave configuration does not match the configuration in the master controller.
-1	Initialised	Indicates that the SM-PROFIBUS DP-V1 has initialized correctly, and is waiting for the PROFIBUS-DP master to initialize communications.
-2	Internal hardware failure	Indicates that part of the SM-PROFIBUS DP-V1 initialisation sequence was not successful. If this fault persists after a power cycle, replace the SM-PROFIBUS DP-V1.
-3	Configuration error	Indicates an invalid setting in the SM-PROFIBUS DP-V1 configuration parameters. Parameters Pr MM.49 and Pr MM.50 will contain additional information.

If a mapping configuration error (see section 10.7 *Mapping status*) or network error (see section 10.9 *Module error code*) is detected, the drive may trip.

5.8 Re-initializing the SM-PROFIBUS DP-V1

Table 5.9 SM-PROFIBUS DP-V1 re-initialize

Pr MM.32	Default	0 (OFF)
	Range	0 (OFF) to 1 (ON)
	Access	RW

Changes to the SM-PROFIBUS DP-V1 configuration in menu 15, 16 and 17 parameters will not take effect until the SM-PROFIBUS DP-V1 has been re-initialized.

To re-initialize SM-PROFIBUS DP-V1:

- Set Pr **MM.32** to ON.
- When the sequence has been completed, Pr **MM.32** will be reset to OFF.
- The SM-PROFIBUS DP-V1 will re-initialise using the updated configuration.

NOTE This sequence does NOT store the SM-PROFIBUS DP-V1 configuration parameters in the drive or the SM-PROFIBUS DP-V1 flash memory. This will change back to 0 immediately and as such the change may not be visible on the display.

5.9 Re-initialize all Solutions Modules

To re-initialize all Solutions Modules installed on a drive:

Unidrive SP, Affinity and Digitax ST

- Set Pr **xx.00** to 1070
- Reset the drive

Mentor MP

- Set Pr **xx.00** to 1070 or SAVE
- Reset the drive

Commander SK

- Set Pr **xx.00** (not Pr **0.00**) to 1070
- Reset the drive

NOTE On Commander SK, to reset the option module using the keypad, one of the configurable parameters (Pr **61** to Pr **70**) must be used. For example, setting Pr **71** to 1.00 and Pr **61** to 1000 will set the value 1000 in Pr **1.00**.

NOTE This sequence does NOT store the SM-PROFIBUS DP-V1 configuration parameters in the drive or the SM-PROFIBUS DP-V1 flash memory.

5.10 Saving parameters to the drive

To avoid loss of the configured settings when the drive is powered down it is necessary to store the parameters in the drive's memory.

To store the drive parameters refer to the relevant drive documentation.

The drive will store all the drive parameters (except applications menu 20) but the operation of the SM-PROFIBUS DP-V1 will not be affected. Any changes made to the SM-PROFIBUS DP-V1 configuration parameters (mapping etc.) will not take effect until the SM-PROFIBUS DP-V1 module is reset.

NOTE On drives with multiple option module slots, the applications menu 20 may be saved if an SM-Applications module is installed, menu 20 is stored in the SM-Applications module's memory. See the SM-Applications documentation for more information.

5.11 Network compatibility mode

Table 5.10 Network compatibility mode

Pr MM.41	Default	0 (SM-PROFIBUS DP-V1)
	Range	0 to 3
	Access	RW

A backwards compatibility mode has been added in SM-PROFIBUS DP-V1 firmware V03.01.00 and later. Pr **MM.41** can be used to allow the SM-PROFIBUS DP-V1 module to appear as either a Unidrive Classic / Mentor II or a Commander SE, this only applies to the network and not the control/status words and parameter sizes. The module must be configured to match the existing network settings of the drive it is replacing (including any parameter mappings).

Table 5.11 Compatibility mode settings

Pr MM.41	Description
0	SM-Profibus DP-V1 (default)
1	Unidrive Classic / Mentor II
2	Commander SE
3	Extended Diagnostics (using PROFIBUS ID 0x0B4F)

Using the compatibility mode allows the replacement of drives on a PROFIBUS-DP network, without having to make any changes to the master network configuration, it changes the identity code of the module so that the master believes that a different drive is present for a particular node.

When using the compatibility mode, the correct GSD file for the simulated drive must be used and not the SM-Profibus DP-V1 GSD file.

NOTE When the network compatibility mode is used (Pr **MM.41** = 1 or 2), DP-V1 functionality and the PROFIdrive (V4) profiles will not be available.

NOTE Depending on the application, an SM-Applications module may be needed on the drive to account for any changes between the functionality of the two drives (i.e. any changes between the control and status words).



WARNING

When the network compatibility mode is used (Pr **MM.41** = 1 or 2), this only changes the drive to emulate the Commander SE, Unidrive Classic or Mentor II PROFIBUS-DP network identification code, the drive functionality and operation is not emulated. Changes to the control method and data size differences must still be considered. This mode does **NOT** allow direct replacement.

When using extended diagnostics (Pr **MM.41** = 3), the appropriate GSD file using the correct PROFIBUS identification code (0x0B4F) must be used (e.g. 'SP__0B4F.GSD').

5.11.1 Extended diagnostics

With the release of V03.02.03 firmware, SM-PROFIBUS DP-V1 has the option of using an additional 8 bytes of extended diagnostics, this extended diagnostics information is appended to the normal diagnostics message sent from the drive to the master and is shown in the table overleaf.

Table 5.12 Extended diagnostics frame

Byte							
0	1	2	3	4	5	6	7
MSB	LSB	MSB	LSB		LSB	MSB	
Status Word (Pr 10.40)		Warning Word		Active Trip Code	Module ID Code		Module Trip Code
b0 = Pr 10.01	b1 = Pr 10.02						
b2 = Pr 10.03	b3 = Pr 10.04						
b4 = Pr 10.05	b5 = Pr 10.06						
b6 = Pr 10.07	b7 = Pr 10.08	b0 = Pr 10.16		Pr 10.20	Pr MM.01		Pr MM.50
b8 = Pr 10.09	b9 = Pr 10.10	b1 = Pr 10.17					
b10 = Pr 10.11	b11 = Pr 10.12	b2 = Pr 10.18					
b12 = Pr 10.13	b13 = Pr 10.14	b3 to b15 = Reserved					
b14 = Pr 10.15	b15 = Reserved						

The values returned are in hexadecimal format.

NOTE

The module ID byte order is reversed compared to the status and warning words.

Example:

For an over-temperature trip on the SM-PROFIBUS DP-V1 module, the active trip code will be "CA" (converting to decimal gives the trip code 202 -SL1.Err), the module ID code will be "9301" (transposing the byte order and converting to decimal gives the code 403) and the module trip code will be "4A" (74 in decimal).

In order to use the extended diagnostic frame, the module needs to be configured to use the PROFIBUS identification code 0x0B4F, this is achieved by setting Pr **MM.41** to a value of 3 and re-initialising the module (Pr **MM.32**=ON). A drive save should be performed if this value is to be retained after a power cycle.

The appropriate GSD file for the drive must also be used in the master controller. (e.g. for Unidrive SP, the file is 'SP__0B4F.GSD').

For GSD compatibility please refer to section 6.5 *GSD compatibility flowchart* on page 25.

6 GSD Files

6.1 What are GSD Files?

GSD files are text files that are used by the PROFIBUS-DP network configuration software tools. They contain information about the device timings, supported features and available data formats for the PROFIBUS-DP device. Drive icon files are also supplied for use with the PROFIBUS-DP configuration software. GSD files are available from your supplier, local Control Techniques Drive Centre or the Control Techniques website (www.controltechniques.com).

6.2 Data consistency

There is a potential problem with data skew when transferring blocks of data to and from a PROFIBUS-DP master controller. Data skew happens when a value is spread across multiple words; when this occurs it is possible that only half of the correct value reaches the destination. Consider the following example:

- The PLC has a value of 0xFFFFFFFF to send to the drive.
- The drive currently has a value of 0x00000000 in a 32-bit parameter.
- The master sends the word without consistency.
- The drive receives one 16-bit word and now has the value 0x0000FFFF.
- The drive receives the next 16-bit word and now has the value 0xFFFFFFFF.

To prevent data skew PROFIBUS-DP has a feature known as 'data consistency'. Consistent data defines a block of data words that must ALL be updated before ANY of the new data values are transmitted. Consequently, the message sent over the PROFIBUS-DP network will have a true representation of the required data. Some PLCs have special functions available to transfer blocks of consistent data to a PROFIBUS-DP master controller and guarantee that data skew cannot occur.

6.2.1 Limitations of non-cyclic data Mode 1 - CT Single Word with GSD

CT Single Word non-cyclic data uses only 1 word of data, however when used without data compression (see section 12.5 *Cyclic data compression*) this requires two 16-bit words (a single 32-bit word). When used without compression only the lower 16 bits of the 32-bit word are used.

6.2.2 Using non-cyclic data Mode 2 - PPO 4 Word

Data consistency is important when using PPO4 word (Mode 2) non-cyclic data as each non-cyclic message consists of four words. If there is data skew between any of the non-cyclic words this could result in the wrong data value being written to the wrong parameter.

The GSD file provides the PPO 4 Word which consists of four IN/OUT words with consistency.

Safety Information
Introduction
Mechanical Installation
Electrical Installation
Getting started
GSD Files
Cyclic data
Non-cyclic data
Control and status words
Diagnostics
PRODrive profile (V4)
Advanced features
Legacy features
Quick reference
Glossary of terms
Index

6.3 Data configuration

The GSD file describes the modules of input or output words that may be combined to configure the input and output configuration for a specific node. The complete input and output configuration for the node is built by adding the required modules until all of the node's inputs and outputs are defined.

NOTE A module consists of a block of input or output data. Put simply this is a logical collection of data words.

If non-cyclic data is required and the DP-V1 non-cyclic channel is not used then the non-cyclic CT Single Word and/or the PPO 4 Word modules must be selected. A total of eight different modules can be selected to configure the input and output configuration of the node.

The number of input or output words configured in the drive must match the number of input or output words defined in the master; if the master has eight IN and four OUT words the drive must use the same settings to communicate correctly.

The SM-PROFIBUS DP-V1 module uses Pr **MM.05** to set the number of input and output words (16-bit) where there are the same number of input and output words, alternatively Pr **MM.39** and Pr **MM.40** may be used to independently set the number of input and output words. See section 12.8 *Custom data formats* for more details.

NOTE The definition of a data word is 16 bits. By default SM-PROFIBUS DP-V1 casts all data as long words/double words (32 bits), data compression can be used to reduce this size, see section 12.5 *Cyclic data compression* for more information.

6.4 GSD compatibility

For Profibus DP-V1 features to be available to the PLC, the appropriate DP-V1 GSD file must be installed and the drive configured in the master PLC as a 'DPV1' slave.

If a DP-V0 GSD file is installed then the DP-V1 features of SM-PROFIBUS DP-V1 will not be available.

6.5 GSD compatibility flowchart

The flowchart in Figure 6-1 can be used to determine which GSD file should be used.

Figure 6-1 SM-PROFIBUS hardware and GSD file compatibility flowchart

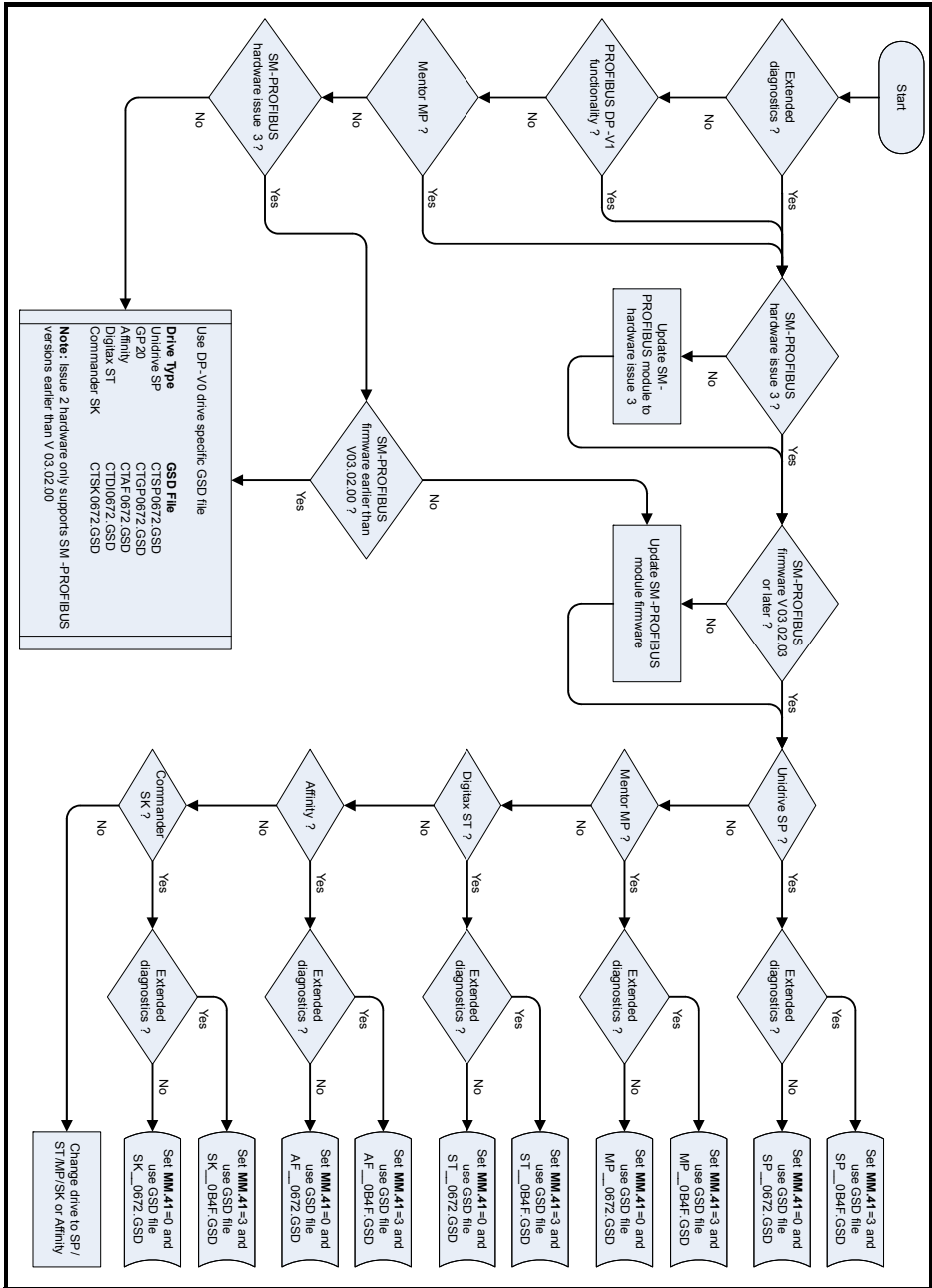

Safety Information
Introduction
Mechanical Installation
Electrical Installation
Getting started
GSD Files
Cyclic data
Non-cyclic data
Control and status words
Diagnostics
PROFIBUS profile (V4)
Advanced features
Legacy features
Quick reference
Glossary of terms
Index

7 Cyclic data

7.1 What is cyclic data?

Cyclic data transfer is a method of transferring data on a regular time period, often known as 'polled data'. High-speed data transfer is achieved by transmitting only data bytes over the PROFIBUS-DP network and using local mapping information within the SM-PROFIBUS DP-V1 and PROFIBUS-DP master controller to ensure that the correct data is sent to the correct locations. The flexibility of the SM-PROFIBUS DP-V1 means that each cyclic data OUT channel can be directed to any read/write drive parameter. Similarly each cyclic data IN channel can use any drive parameter as a source of data.

NOTE

- The term OUT data refers to data that is transmitted out of the master to the slave.
- The term IN data refers to data that is returned from a slave into the master.
- Cyclic data mapping cannot be changed dynamically, as changes to the configuration (mapping parameters, etc.) will only take effect during initialisation of the SM-PROFIBUS DP-V1.
- The maximum number of 16-bit mappings that is possible is: 32 with only cyclic data, 31 with CT Single Word (Mode 1) non-cyclic data and 28 with PPO4 Word (Mode 2). This requires data compression to be enabled, see section 12.5 *Cyclic data compression* for more information.
- The maximum number of 32-bit mappings that is possible is: 16 with only cyclic data, 15 with CT Single Word (Mode 1) non-cyclic data and 14 with PPO4 Word (Mode 2).

See section 12.5 *Cyclic data compression* for information on using data compression with 16-bit parameters.

7.2 Data formats

The SM-PROFIBUS DP-V1 can be configured with up to sixteen 32-bit or thirty-two 16-bit cyclic IN and OUT data words. IN and OUT cyclic data words are mapped using ten mapping (pointer) parameters, one for each mapping.

To utilize the full range of thirty-two cyclic IN and OUT data words the 'block mapping' mode must be used (see section 12.6 *Block mapping*).

NOTE

By default all drive parameters are cast as 32-bit (two 16-bit words) therefore thirty-two cyclic words gives sixteen possible drive parameters. Data compression reduces the number of cyclic words required for drive parameters of 16-bit (or less) to 16 bits thus allowing for thirty-two possible 16-bit parameters. Any 32-bit parameters mapped will still require two 16-bit words even with compression turned on.

In addition to cyclic data, non-cyclic data (see section 8.1 *What is non-cyclic data?*) exchange is also possible by the following methods:

- DP-V1 parameter access mode.
- Mode 1 - CT single word mode
- Mode 2 - PPO 4 Word mode.

For Modes 1 and 2 operation, the SM-PROFIBUS DP-V1 data format is specified as NNCC, where NN is the non-cyclic data mode, and CC is the number of cyclic data words.

Table 7.1 Valid PROFIBUS-DP data formats

Pr MM.05	N	CC	Non-cyclic mode	Cyclic words
1 to 32	0	1 to 32	None	1 to 32
100 to 131	1	0 to 31	CT Single Word	1 to 31
200 to 228	2	0 to 28	PPO 4 Word	1 to 28

The method used to map data to and from the PROFIBUS-DP network is similar to the method used in the drive for mapping analog and digital I/O. The reference for the source or target parameter is entered in the mapping parameter in the form **MM.PP**, where:

MM = menu number of the target/source parameter

PP = parameter number of the target/source parameter.

Table 7.2 SM-PROFIBUS DP-V1 mapping parameters

IN channel	Mapping parameter	OUT channel	Mapping parameter
0	Pr MM.10	0	Pr MM.20
1	Pr MM.11	1	Pr MM.21
2	Pr MM.12	2	Pr MM.22
3	Pr MM.13	3	Pr MM.23
4	Pr MM.14	4	Pr MM.24
5	Pr MM.15	5	Pr MM.25
6	Pr MM.16	6	Pr MM.26
7	Pr MM.17	7	Pr MM.27
8	Pr MM.18	8	Pr MM.28
9	Pr MM.19	9	Pr MM.29

NOTE A cyclic data channel does not use decimal points. For example, in Open Loop mode, digital speed reference 1 (Pr **1.21**) has units of Hertz, accurate to 1 decimal place. To write a value of 24.6Hz to Pr **1.21**, the value must be transmitted as 246.

Block mapping can be used to map several words to consecutive drive parameters. Full details about block mapping can be found in section 12.6 *Block mapping*.

When the data format is configured using Pr **MM.05**, the SM-PROFIBUS DP-V1 will communicate using the same number of data words for IN and OUT data. It is, however, possible to configure the SM-PROFIBUS DP-V1 to communicate with different numbers of IN and OUT cyclic data words. Refer to section 12.8 *Custom data formats* for full details.

If a mapping parameter is set to an invalid value (e.g. destination parameter is read only, or parameter does not exist) the SM-PROFIBUS DP-V1 will indicate a configuration error in the operating status parameter (Pr **MM.06**). The reason for the configuration error will be indicated by the mapping status parameter (Pr **MM.49**). Refer to section 10.7 *Mapping status* for more details.

The following sections show some example data formats that can be selected, and the parameter mapping that will apply (by default) to each format.

Safety Information
Introduction
Mechanical Installation
Electrical Installation
Getting started
Files
Cyclic data
Non-cyclic data
Control and status words
Diagnostics
PROFIDrive profile (V4)
Advanced features
Legacy features
Quick reference
Glossary of terms
Index

7.2.1 Two cyclic channels only (default - compression off)

This data format provides two cyclic data channels with no non-cyclic data. The total data length is four words in and four words out.

To select this data format, set Pr **MM.05** = 4. This data format is selected by default.

Table 7.3 Mapping for four cyclic data words

Data word	Parameter	Default mapping
IN word 0, 1	Pr MM.10	Pr 10.40 , status word
IN word 2, 3	Pr MM.11	Pr 2.01 , post-ramp speed reference
OUT word 0, 1	Pr MM.20	Pr 6.42 , control word
OUT word 2, 3	Pr MM.21	Pr 1.21 , digital speed reference 1

7.2.2 Three cyclic channels with Mode 1 non-cyclic data (compression off)

This data format provides three cyclic data channels, plus an additional channel for Mode 1 (CT Single Word) non-cyclic data (See section 8.6 *Mode 1 - CT Single Word mode*). The total data length is eight words in and eight words out.

To select this data format, set Pr **MM.05** = 106.

Table 7.4 Mapping for three cyclic channels with CT Single Word non-cyclic data

Data word	Parameter	Default mapping
IN word 0, 1	Pr MM.10	Pr 61.50 , CT Single Word
IN word 2, 3	Pr MM.11	Pr 10.40 , status word
IN word 4, 5	Pr MM.12	Pr 2.01 , post-ramp speed reference
IN word 6, 7	Pr MM.13	0, not mapped
OUT word 0, 1	Pr MM.20	Pr 61.50 , CT Single Word
OUT word 2, 3	Pr MM.21	Pr 6.42 , control word
OUT word 4, 5	Pr MM.22	Pr 1.21 , digital speed reference 1
OUT word 6, 7	Pr MM.23	0, not mapped

7.2.3 Five cyclic channels only (compression off)

This data format provides five cyclic data channels, with no non-cyclic data channel. The total data length is ten words in and ten words out.

To select this data format, set Pr **MM.05** = 10

Table 7.5 Mapping for five cyclic channels

Data word	Parameter	Default mapping
IN word 0, 1	Pr MM.10	Pr 10.40 , status word
IN word 2, 3	Pr MM.11	Pr 2.01 , post-ramp speed reference
IN word 4-9	Pr MM.12 to Pr MM.14	0, not mapped
OUT word 0, 1	Pr MM.20	Pr 6.42 , control word
OUT word 2, 3	Pr MM.21	Pr 1.21 , digital speed reference 1
OUT word 4-9	Pr MM.22 to Pr MM.24	0, not mapped

7.2.4 Eight cyclic channels with Mode 2 non-cyclic data (compression off)

This data format provides eight cyclic data channels, plus an additional four words for Mode 2 (PPO 4 Word) non-cyclic data (See section 8.8 *Mode 2 - PPO 4 Word mode*). The total data length is twenty words in and twenty words out. To select this data format set Pr **MM.05** = 216.

Table 7.6 Mapping for eight cyclic channels with PPO 4 Word non-cyclic data

Data word	Parameter	Default mapping
IN word 0-3	Pr MM.10	Pr 61.51 , Mode 2 non-cyclic data
IN word 4, 5	Pr MM.11	Pr 10.40 , status word
IN word 6, 7	Pr MM.12	Pr 2.01 , post-ramp speed reference
IN word 8-19	Pr MM.13 to Pr MM.19	0, not mapped
OUT word 0-3	Pr MM.20	Pr 61.51 , Mode 2 non-cyclic data
OUT word 4, 5	Pr MM.21	Pr 6.42 , control word
OUT word 6, 7	Pr MM.22	Pr 1.21 , digital speed reference 1
OUT word 8-19	Pr MM.23 to Pr MM.29	0, not mapped

7.3 Mapping conflicts

Care must be taken to ensure that there are no clashes between mappings in the SM-PROFIBUS DP-V1 cyclic OUT data and other drive parameters such as:

- other SM-PROFIBUS DP-V1 cyclic OUT channels
- mappings from additional SM modules if installed (Not Commander SK)
- analog inputs
- digital inputs
- logic outputs
- motorized pot output
- comparator outputs
- variable selected outputs

The SM-PROFIBUS DP-V1 will not indicate if there is a mapping conflict due to any one of the reasons listed. Should a conflict occur and a parameter is written to from two or more different sources, the value of this parameter will depend entirely upon the scan times for the function and the PROFIBUS-DP network. The result would be that a parameter may appear to be steady at a particular value on the drive display, although an occasional glitch in the displayed value may be seen. However, internally, this value may be changing continuously between two values, leading to unusual behavior from the drive.

7.4 Cyclic data mapping errors

The SM-PROFIBUS DP-V1 module will scan and check the PROFIBUS-DP mapping parameter configuration for errors during initialisation. If an error is detected, then the SM-PROFIBUS DP-V1 operating status parameter (Pr **MM.06**) will indicate -3, and the configuration error detected will be indicated in mapping status parameter, Pr **MM.49**. See section 10.7 *Mapping status* for full details.

7.5 Mapping limitations

When setting mapping values care should be taken not to exceed the data size set in Pr **MM.05** (or Pr **MM.39** and Pr **MM.40**). The data size depends on the size of the mapped parameter and if data compression is turned on or not (see Table 7.7).

Table 7.7 Actual data sizes

Parameter size (bits)	Actual data size (bits) compression on	Actual data size (bits) compression off
1	16	32
8	16	32
16	16	32
32	32	32

Consider the following example:

- mapping Pr **MM.10** to a 32-bit value and **MM.11** to a 16-bit value
- mapping Pr **MM.20** to a 32-bit value and **MM.21** to a 32-bit value
- data compression turned on (Pr **MM.34** set to ON)

would require the following settings:

- Pr **MM.39** = 3
- Pr **MM.40** = 4

If the size of the input and output mappings are identical then Pr **MM.05** can be used to set the mapping length.

7.6 Disabling mappings

Any unused mapping parameters (Pr **MM.10** to Pr **MM.19** and Pr **MM.20** to Pr **MM.29**) should be set to 0.

NOTE

Having unmapped channels between valid mapped channels is not permitted and will result in a configuration error (i.e. Pr **MM.06** will indicate -3).

8 Non-cyclic data

8.1 What is non-cyclic data?

Non-cyclic data allows access to any parameter without the need to use cyclic data transfers. This is particularly useful when accessing many different parameters for set-up or archiving of drive settings. There are three methods of using non-cyclic data on the SM-PROFIBUS DP-V1:

- DP-V1 Parameter Access
- Mode 1 - CT Single Word
- Mode 2 - PPO 4 Word

8.1.1 DP-V1 Parameter Access

Non-cyclic data is transmitted after all the cyclic data within the PROFIBUS-DP cycle, depending on the length of the non-cyclic data, this may take several cycles to complete.

8.1.2 Mode1 - CT Single Word

This mode uses an additional data word to implement the CT Single Word protocol, allowing access any drive parameter. See section 8.6 *Mode 1 - CT Single Word mode* for more information.

8.1.3 Mode 2 - PPO 4 Word

This mode uses four data words to access any drive parameter. See section 8.8 *Mode 2 - PPO 4 Word mode* for more information.

8.2 Configuration using non-cyclic data

The SM-PROFIBUS DP-V1 can be configured using the DP-V1 Parameter Access channel, CT Single Word or PPO 4 Word non-cyclic data. This is useful when using a master controller to configure the drive; when a drive is initialized only the node address **MM.03** and the data mode **MM.05**, need to be set manually. The master can now use the desired mode to setup the remainder of the parameters.

The configuration parameters for the slot in which the SM-PROFIBUS DP-V1 is located can be accessed as Pr **60.PP**. Any changes made to the configuration parameters will not take effect until the SM-PROFIBUS DP-V1 has been reset. SM-PROFIBUS DP-V1 can be reset by writing a value of 1 to Pr **60.32**. A brief interruption in PROFIBUS-DP communications may be seen while the reset sequence is in progress.

8.3 PROFIBUS DP-V1 Compatibility

The additional features that PROFIBUS DP-V1 provide are only available on drives installed with SM-PROFIBUS DP-V1, with firmware V03.02.00 or later.

NOTE When the network compatibility mode is used (Pr **MM.41** = 1 or 2), DP-V1 functionality and the PROFdrive (V4) profiles will not be available.

NOTE In order to use the DP-V1 features, the appropriate DP-V1 GSD file must be installed in the master PLC.

8.4 PROFIBUS DP-V1 Overview

The PROFIBUS DP-V1 specification allows for the standard cyclic process data (as defined in the DP-V0 specification) and the additional acyclic parameter data to be transmitted in the same bus cycle.

The DP-V1 message is contained within the acyclic part of the PROFIBUS-DP cycle and uses the slave node address to access the parameter channel.

For further details of the PROFIBUS DP-V1 functionality refer to the official PROFIBUS website at www.profibus.com

The following services will be supported:

- Class 1 Master Read and Write
- Class 2 Master Read and Write
- Class 2 Master Initiate Connection
- Class 2 Master Abort Connection

A class 1 master must be in data exchange with the slave before it can perform a request via the DP-V1 channel. A class 2 master must initiate the connection with the slave before sending the DP-V1 message, likewise it must then abort the connection when it is no longer required.

NOTE

SM-PROFIBUS DP-V1 supports the simultaneous connection to one class 1 master and one class 2 master.

SM-PROFIBUS DP-V1 supports the following features:

- DP-V1 Parameter Access
- PROFIdrive PNU Access (see section 11.11 *PROFIdrive PNU access*)
- Fault Buffer (see section 11.12 *Fault Buffer*)
- Drive Identification (see section 11.13 *Drive Identification*)
- Identification and Maintenance Functions (see section 11.14 *Identification and Maintenance Functions*)

The maximum DP-V1 message length is restricted to 128 bytes including the four bytes of the DP-V1 header and the four bytes of the PROFIdrive request, this leaves a maximum of 120 bytes for the parameter data; the maximum number of parameters that can be read or written in a single message is shown in Table 8.1.

Table 8.1 Single message parameter limitation

Mode	Maximum number of parameters	
	16-bit	32-bit
Read	20	20
Write	12	10

8.4.1 DP-V1 Parameter Access

Drive parameters (and PROFdrive PNUs) can be accessed using the PROFdrive Parameter Channel, the global slot number 0 and slot sub-index 47. This is illustrated in Figure 8-1.

NOTE DP-V1 slot numbers 1 and 2 are also allowed.

NOTE The PROFdrive PNUs will be accessible using functions available in the master.

Figure 8-1 DP-V1 Parameter Channel

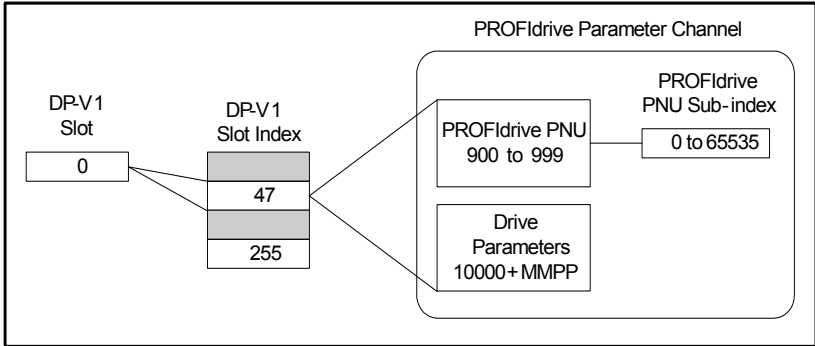

The parameter channel requires a parameter index and subindex to access parameters.

Drive parameters can be accessed by placing the result of the equation

10000 + (MM * 100) + PP in the parameter Index field of the PROFdrive request, the sub-index field is always set to 0.

For example, Pr **1.21** (Preset Reference 1) would be entered as

$$10000 + (1 * 100) + 21 = 10121.$$

PROFdrive Parameters (PNUs) can be accessed by placing the PNU number in the parameter index field and if the PNU data type is an array, then the sub-index field may also be specified.

8.5 Setting the non-cyclic mode (non-cyclic over cyclic)

The term 'non-cyclic over cyclic' is used to refer to non-cyclic data which is transmitted as part of the cyclic data and not using the non-cyclic DP-V1 channel.

Table 8.2 shows how to configure the data mode (Pr **MM.05**) for the required non-cyclic mode. The value in this parameter is formed using three digits, the most significant of these determines the non-cyclic mode. The two least significant digits (*CC*) determine the number of cyclic words for both IN and OUT data.

Table 8.2 Non-cyclic over cyclic data modes

Non-cyclic mode	Value For Mode	Format	Pr MM.05
Disabled	0	None	0CC
Mode 1	1	CT Single Word	1CC
Mode 2	2	PPO 4 Word	2CC

Figure 8-2 shows the relationship between the value entered in Pr **MM.05** and the cyclic and non-cyclic data set-up.

Figure 8-2 Non-cyclic data words

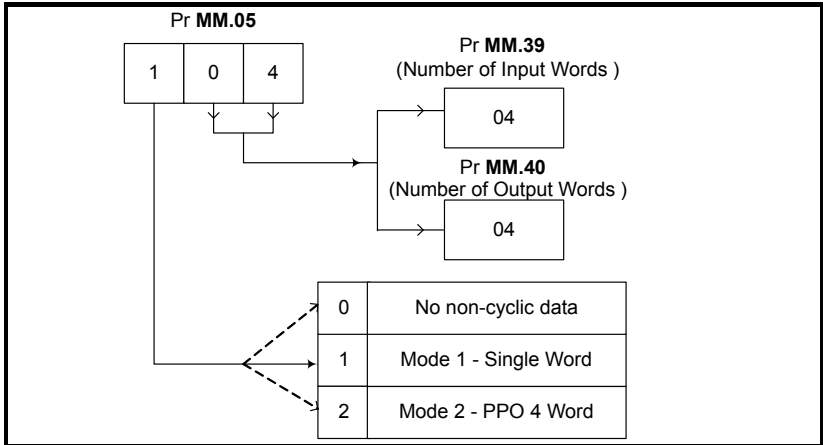

8.6 Mode 1 - CT Single Word mode

The CT Single Word (Mode 1) uses one cyclic channel for non-cyclic data. This non-cyclic sub-protocol requires a specific sequence of four or six telegrams to implement the parameter access. Each non-cyclic word or telegram is split into two bytes to implement the sub-protocol. The high byte containing the control codes for each telegram and the low byte containing the data for each telegram.

NOTE By default cyclic data compression is disabled, the CT Single Word non-cyclic channel will be 32 bits wide (i.e. uses two words, and data must be transferred on the low word). If cyclic data compression is enabled the CT Single Word non-cyclic channel will revert to 16 bits and only use a single word.

8.6.1 Mapping For CT Single Word non-cyclic data

To configure an SM-PROFIBUS DP-V1 for CT Single Word mode the following steps must be performed:

1. Set Pr **MM.05** to the required mode. See section 7.2 *Data formats* on page 26 for more information.
2. Set Pr **MM.32** to ON to reset. See section 5.9 *SM-PROFIBUS DP-V1 re-initialize* on page 20.
3. Save the parameters if required (see section 5.10 *Saving parameters to the drive* for more information).

When the SM-PROFIBUS DP-V1 re-initializes, it will map cyclic data IN Word 0 and cyclic data OUT Word 0 to the CT Single Word protocol parameter (Pr **61.50**). All existing mapping parameters will be moved down by one word, (i.e. the previous mappings set in Pr **MM.10** and Pr **MM.20** will now appear in Pr **MM.11** and Pr **MM.21**). Table 8.3 shows what happens to the mappings when the data format is changed from four cyclic words to four cyclic words with CT Single Word non-cyclic data.

Table 8.3 CT Single Word non-cyclic data mapping

Mapping parameter	Before format change (Pr MM.05 = 4)		After format change (Pr MM.05 = 104)	
	Value	Mapping	Value	Mapping
Pr MM.10	1040	Pr 10.40, status word	6150	Pr 61.50, CT Single Word
Pr MM.11	201	Pr 2.01, post ramp speed ref	1040	Pr 10.40, status word
Pr MM.12	0	Not mapped	201	Pr 2.01, post ramp speed ref
Pr MM.13 to Pr MM.19	0	Not mapped	0	Not mapped
Pr MM.20	642	Pr 6.42, control word	6150	Pr 61.50, CT Single Word
Pr MM.21	121	Pr 1.21, digital speed ref 1	642	Pr 6.42, control word
Pr MM.22	0	Not mapped	121	Pr 1.21, digital speed ref 1
Pr MM.23 to Pr MM.29	0	Not mapped	0	Not mapped

NOTE If all IN or OUT mapping parameters are being used when the data format change is implemented the last mapping parameter value will be lost.

8.6.2 CT Single Word protocol

All parameter values for the drive must be written as signed 32-bit data values with data compression off. If data compression is turned on the size of the mapping will depend on the size of the source or destination parameter.

NOTE Decimal point information is inserted automatically when the data value is written to the drive and removed when the data value is read. The number of decimal places of the target parameter must be known. Writing a value of 1234 to a parameter with two decimal places will produce a value of 12.34 in the target parameter. Similarly, reading a value of 12.34 will return a 32-bit integer value of 1234.

Table 8.4 CT Single Word Bit Positions

b15	b14	b13	b12	b11	b10	b9	b8
READ	ERR	Reserved	32-BIT	Stamp Number			
b7	b6	b5	b4	b3	b2	b1	b0
Data Byte							

Table 8.5 CT Single Word Bit Definitions

Bit	Function	Values	Description
0 to 7	Data	0 to 255	Depending on the stamp number of the telegram, this byte contains the menu, parameter or data byte.
8 to 11	Stamp number	0 to 6	Indicates the stamp number of the word. This shows which part of the message is currently in progress. Setting the stamp number to 0 resets the internal non-cyclic state machine.
12	32-BIT	0 = 16-bit data 1 = 32-bit data	Specifies whether a 16-bit or 32-bit data value is to be written to or read from the drive. If 32-BIT is set, telegrams 5 and 6 will be used to transfer the additional data bytes.
13	Reserved	0	Reserved for future use. Always set to 0.
14	ERR	0 = Data OK 1 = Error	Indicates the success or failure of the message. Failure could occur if the parameter does not exist, or is a read-only or write-only parameter. This bit will also be set if the parameter value is out of range in 16-bit mode.
15	READ	0 = Write 1 = Read	Defines whether the data word is part of a READ or WRITE cycle.

NOTE Setting the stamp number to 0 resets the internal non-cyclic state machine. Allowing a new message to be started.

NOTE CT Single Word non-cyclic data uses only one word of data, when using this without data compression this requires two 16-bit words. If Mode 1 is used with compression turned off only the least significant word of the 32-bit word is used.

8.7 Reading parameters using CT Single Word

To read 32-bit parameters using the non-cyclic channel, the following “telegrams” must be transmitted to construct the final message:

- Telegram 1 - define menu number
- Telegram 2 - define parameter number
- Telegram 3 - request high data byte
- Telegram 4 - request mid-high data byte
- Telegram 5 - request mid-low data byte
- Telegram 6 - request low data byte

Table 8.6 CT Single Word Bit Positions

b15	b14	b13	b12	b11	b10	b9	b8
READ	ERR	Reserved	32-BIT	Stamp Number			
b7	b6	b5	b4	b3	b2	b1	b0
Data Byte							

8.7.1 Constructing CT Mode 1 Single Word Read Messages

Figure 8-3 CT Single Word read sequence (Mode 1)

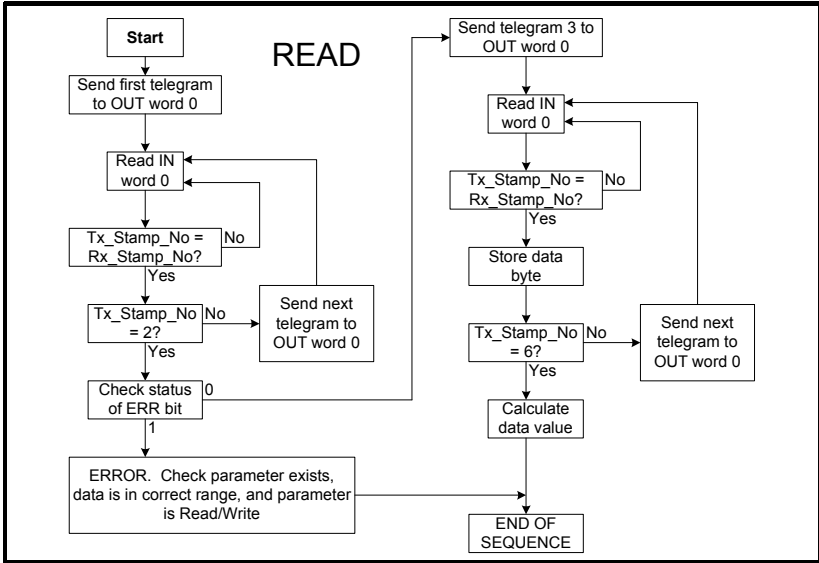

The following example telegrams show how to read the post-ramp speed reference (in rpm with one decimal places) from Pr **2.01** on the drive.

TELEGRAM 1

The first telegram from the PROFIBUS-DP master indicates a READ with stamp number 1. The data byte contains the menu number of the parameter that is to be read.

Example telegram

Bit	b15-b12	b11-b8	b7-b4	b3-b0
Value	1001	0001	0000	0010

Data word = 0x9102

Stamp number = 1

Menu = 2

When the first telegram has been received and processed in the slave node, it is mirrored in the non-cyclic IN word back to the PLC. This is the signal to the master controller program that the first telegram of the message has been received and understood the second telegram can now be transmitted.

Example response

Bit	b15-b12	b11-b8	b7-b4	b3-b0
Value	1001	0001	0000	0010

Data word = 0x9102

Stamp number = 1

NOTE If a telegram produces an error at any point in the sequence the reply to the master will have the error bit ERR set to a 1.

TELEGRAM 2

The second telegram from the PROFIBUS-DP master also indicates a READ cycle, but the stamp number is now 2. The data byte would contain the parameter number for the parameter that is to be read.

Example telegram

Bit	b15-b12	b11-b8	b7-b4	b3-b0
Value	1001	0010	0000	0001

Data word = 0x9201

Stamp number = 2

Parameter = 1

When the second telegram has been received and processed in the slave, it is mirrored in the non-cyclic IN word. This is the signal to the master controller program that the second telegram of the message has been received and the third telegram can now be transmitted.

NOTE

If telegrams 1 and 2 were not received correctly or an invalid parameter was specified, (e.g. parameter is write only, or does not exist), the PROFIBUS-DP interface will set the ERROR bit to 1 (b14 = 1) in the response. The data bits will have no significance. Setting the stamp number to 0 resets the internal non-cyclic state machine.

Example response

Bit	b15-b12	b11-b8	b7-b4	b3-b0
Value	1001	0010	0000	0001

Data word = 0x9201

Stamp number = 2

NOTE

If an error is reported, the non-cyclic data word should be set to 0 to ensure that the non-cyclic state machine is completely reset and ready for the next non-cyclic READ or WRITE sequence.

TELEGRAM 3

The third telegram from the PROFIBUS-DP master acts as the indication to the slave to send the high data byte from the requested parameter. The data byte is not used in this telegram, and should be set to 0.

Example telegram

Bit	b15-b12	b11-b8	b7-b4	b3-b0
Value	1001	0011	0000	0000

Data word = 0x9300

Stamp number = 3

When the third telegram has been received and processed in the slave node, the node will mirror the stamp number in the non-cyclic IN word and load the high byte of the parameter value into the data byte.

Example response

Bit	b15-b12	b11-b8	b7-b4	b3-b0
Value	1001	0011	0000	0000

Data word = 0x9300

Stamp number = 3

Data high byte = 0x00 = 0

TELEGRAM 4

The fourth telegram from the PROFIBUS-DP master acts as the indication to the slave to send the mid-high data byte from the requested parameter. The data byte is not used in this telegram, and should be set to 0.

Example telegram

Bit	b15-b12	b11-b8	b7-b4	b3-b0
Value	1001	0100	0000	0000

Data word = 0x9400

Stamp number = 4

When the fourth telegram has been received and processed in the slave node, the node will mirror the stamp number in the non-cyclic IN word and load the mid-high byte of the parameter value into the data byte.

Example response

Bit	b15-b12	b11-b8	b7-b4	b3-b0
Value	1001	0100	0000	0001

Data word = 0x9401

Stamp number = 4

Data mid-high byte = 0x01 = 1

TELEGRAM 5

The fifth telegram from the PROFIBUS-DP master acts as the indication to the slave to send the mid-low data byte from the requested parameter. The data byte is not used in this telegram and should be set to 0.

Example telegram

Bit	b15-b12	b11-b8	b7-b4	b3-b0
Value	1001	0101	0000	0000

Data word = 0x9500

Stamp number = 5

When the fifth telegram has been received and processed in the slave node, the node will mirror the stamp number in the non-cyclic IN word and load the mid-low byte of the parameter value into the data byte.

Example response

Bit	b15-b12	b11-b8	b7-b4	b3-b0
Value	1001	0101	0010	0101

Data word = 0x9525

Stamp number = 5

Data mid-low byte = 0x25 = 37

TELEGRAM 6

The sixth telegram from the PROFIBUS-DP master acts as the indication to the slave to send the low data byte from the requested parameter. The data byte is not used in this telegram and should be set to 0.

Example telegram

Bit	b15-b12	b11-b8	b7-b4	b3-b0
Value	1001	0110	0000	0000

Data word = 0x9600

Stamp number = 6

When the sixth telegram has been received and processed in the slave node, the node will mirror the stamp number in the non-cyclic IN word and load the low byte of the parameter value into the data byte.

Example response

Bit	b15-b12	b11-b8	b7-b4	b3-b0
Value	1001	0110	1101	1100

Data word = 0x96DC

Stamp number = 6

Data low byte = 0xDC = 220

8.7.2 The parameter re-assembled

The completed value can be assembled as follows to give the complete value as read from the parameter.

$$\begin{aligned} \text{Speed} &= (\text{High byte} * 2^{24}) + (\text{Mid-high byte} * 2^{16}) + \\ &\quad (\text{Mid-low byte} * 2^8) + \text{Low byte} \\ &= (0 * 16777216) + (1 * 65536) + (37 * 256) + 220 \\ &= 75228 \\ &= 7522.8 \text{ rpm} \end{aligned}$$

8.7.3 Writing parameters using CT Single Word

To write to a 32-bit parameter using the non-cyclic channel, the following telegrams must be sent one telegram per network cycle to construct the final message.

- Telegram 1 - define menu number
- Telegram 2 - define parameter number
- Telegram 3 - send high data byte
- Telegram 4 - send mid-high data byte
- Telegram 5 - send mid-low data byte
- Telegram 6 - send low data byte

Figure 8-4 CT Single Word write sequence

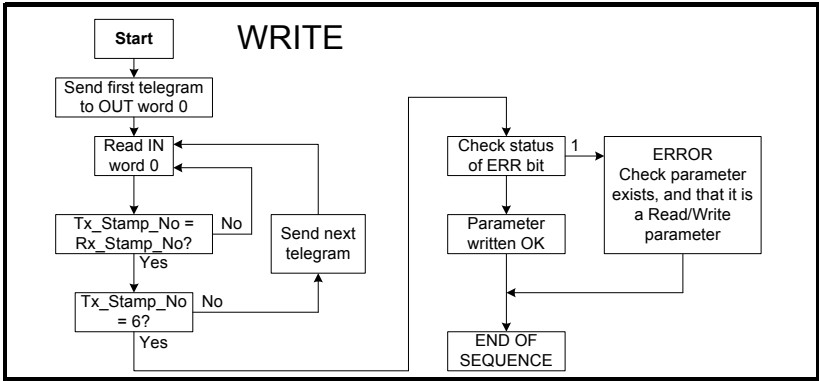

The following telegrams show how to set the digital speed reference 1 (Pr 1.21) to 12553.9 rpm (32-bit value is 125539) in the Unidrive SP.

TELEGRAM 1

The first telegram from the PROFIBUS-DP master indicates a WRITE cycle by setting the R/W bit to 0. The stamp number is set to 1. The data byte contains the menu number for the parameter that is to be written to.

Example telegram

Bit	b15-b12	b11-b8	b7-b4	b3-b0
Value	0001	0001	0000	0001

Data word = 0x1101
Stamp number = 1
Menu = 1

When the first telegram has been received and processed in the slave node, it is mirrored in the non-cyclic IN word. This is the signal to the master controller program that the first telegram of the message has been received and understood and the second telegram can be transmitted.

TELEGRAM 2

The second telegram from the PROFIBUS-DP master also indicates a write cycle, but the stamp number is now set to 2. The data byte would contain the parameter number for the parameter that is to be written to

Example telegram

Bit	b15-b12	b11-b8	b7-b4	b3-b0
Value	0001	0010	0001	0101

Data word = 0x1215
Stamp number = 2
Parameter = 21

When the second telegram has been received and processed in the slave node, it is mirrored in the non-cyclic IN word. This is the signal to the master controller program that the second telegram of the message has been received and understood and the third telegram can be transmitted.

TELEGRAM 3

The third telegram from the PROFIBUS-DP master has the stamp number set to 3. The data bits contain the high data byte for the parameter being written to.

Example telegram

Bit	b15-b12	b11-b8	b7-b4	b3-b0
Value	0001	0011	0000	0000

Data word = 0x1300

Stamp number = 3

Data high byte = 0x00

When the third telegram has been received and processed in the slave node, it is mirrored in the non-cyclic IN word. This is the signal to the master controller program that the third telegram of the message has been received and understood and the fourth telegram can be transmitted.

TELEGRAM 4

The fourth telegram from the PROFIBUS-DP master has the stamp number set to 4. The data bits contain the mid-high data byte for the parameter being written to.

Example telegram

Bit	b15-b12	b11-b8	b7-b4	b3-b0
Value	0001	0100	0000	0001

Data word = 0x1401

Stamp number = 4

Data mid-high byte = 0x01 = 1

When the fourth telegram has been received and processed in the slave node, it is mirrored in the non-cyclic IN word. This is the signal to the master controller program that the fourth telegram of the message has been received and understood and the fifth telegram can be transmitted.

TELEGRAM 5

The fifth telegram from the PROFIBUS-DP master has the stamp number set to 5. The data bits contain the mid-low data byte for the parameter being written to.

Example telegram

Bit	b15-b12	b11-b8	b7-b4	b3-b0
Value	0001	0101	1110	1010

Data word = 0x15EA

Stamp number = 5

Data mid-low byte = 0xEA = 234

When the fifth telegram has been received and processed in the slave node, it is mirrored in the non-cyclic IN word. This is the signal to the master controller program that the fifth telegram of the message has been received and understood and the sixth telegram can be transmitted.

TELEGRAM 6

The sixth telegram from the PROFIBUS-DP master has the stamp number set to 6. The data bits contain the low data byte for the parameter that is being written to.

Example telegram

Bit	b15-b12	b11-b8	b7-b4	b3-b0
Value	0001	0110	0110	0011

Data word = 0x1663

Stamp number = 6

Data low byte = 0x63 = 99

When the sixth telegram has been received and processed in the slave node, it will write the data (Pr 1.21 = 12553.9) as transmitted (the decimal point is automatically inserted when the data is transferred to the drive). If the operation is successful, the ERR bit is reset to 0 and the telegram is reflected in the non-cyclic IN word.

Example response - success

Bit	b15-b12	b11-b8	b7-b4	b3-b0
Value	0001	0110	0110	0011

Data word = 0x1663

Stamp number = 6

Data low byte = 0x63 = 99

If there was a problem with writing the data to the defined parameter, e.g. parameter is read only, does not exist, or data is out of range, the ERR bit is set to 1.

Example response - success

Bit	b15-b12	b11-b8	b7-b4	b3-b0
Value	0101	0110	0110	0011

Data word = 0x5663

Stamp number = 6

8.7.4 Abort CT Single Word non-cyclic message

The internal state machine that controls the non-cyclic data transfer will only accept a new telegram if it contains the next expected telegram (i.e. after accepting Telegram 2, the state machine will only respond to Telegram 3. If Telegram 4 is received, it will be ignored).

If an error occurs in the master controller that causes the telegrams to get out of step, the master controller program should time-out, abort the message and reset the non-cyclic state machine.

A Mode 1 non-cyclic message can be abandoned by resetting the state machine. This is done by setting the non-cyclic word to 0.

Example telegram

Bit	b15-b12	b11-b8	b7-b4	b3-b0
Value	0000	0000	0000	0000

Data word = 0x0000

Stamp number = 0

8.7.5 16-bit parameter access

Normally six telegrams would be required to access drive parameters using Mode 1 non-cyclic data. When accessing 16-bit data only four telegrams are required. If an attempt is made to read a 32-bit parameter from the drive the parameter value will be returned, provided that the parameter value does not exceed signed 16-bit limits. If the value is larger than a signed 16-bit value, the ERR bit will be set. When writing data to a 32-bit parameter, the 16-bit data will be treated as a signed 16-bit data value. This limits the range that can be written to a 32-bit parameter.

8.8 Mode 2 - PPO 4 Word mode

PPO 4 word mode of non-cyclic data is a simple method of accessing non-cyclic data without the need for the telegrams required with Mode 1 non-cyclic data and its associated overheads. Mode 2 has the disadvantage of using four words of mappings and reduces the available free mappings accordingly.

8.8.1 Mapping for PPO 4 Word non-cyclic data

To configure an SM-PROFIBUS DP-V1 for PPO 4 word mode non-cyclic data, the following steps must be performed:

1. Set Pr **MM.05** to the required mode (see section 7.2 *Data formats* on page 26).
2. Set Pr **MM.32** to ON to re-initialize SM-PROFIBUS DP-V1.
3. Save the parameters if required (see section 5.10 *Saving parameters to the drive* for more information).

When the SM-PROFIBUS DP-V1 re-initializes, it will map cyclic data IN words 0 to 3 and OUT words 0 to 3 to the PPO 4 Word protocol parameter, Pr **61.51**. All existing mapping parameters will be moved down by one mapping, (i.e. the previous mappings set in Pr **MM.10** and Pr **MM.20** will now appear in Pr **MM.11** and Pr **MM.21** respectively). Table 8.7 shows what happens to the mapping parameters when the data format is changed from 10 cyclic words (Pr **MM.05**=10) to 10 cyclic words with Mode 2 non-cyclic data. (Pr **MM.05**=210).

Table 8.7 PPO 4 Word mode data mapping

Mapping parameter	Before format change (Pr 17.05 = 10)		After format change (Pr 17.05 = 210)	
	Value	Mapping	Value	Mapping
Pr 17.10	1040	Pr 10.40, status word	6151	Pr 61.51, PPO 4 Word
Pr 17.11	201	Pr 2.01, post ramp speed ref	1040	Pr 10.40, status word
Pr 17.12	0	Not mapped	201	Pr 2.01, post ramp speed ref
Pr 17.13 to Pr 17.19	0	Not mapped	0	Not mapped
Pr 17.20	642	Pr 6.42, control word	6151	Pr 61.51, PPO 4 Word
Pr 17.21	121	Pr 1.21, digital speed ref 1	642	Pr 6.42, control word
Pr 17.22	0	Not mapped	121	Pr 1.21, digital speed ref 1
Pr 17.23 to Pr 17.29	0	Not mapped	0	Not mapped

NOTE If all IN or OUT mapping parameters are being used when the data format change is implemented, the last mapping parameter value will be lost.

8.8.2 PPO 4 Word protocol

Table 8.8 shows the data structure required on the OUT data to implement PPO 4 Word request.

NOTE Decimal point information is inserted automatically when the data value is written to the drive and removed when the data value is read. Hence the number of decimal places of the target parameter must be known. Writing a value of 1234 to a parameter with two decimal places will produce a value of 12.34 in the target parameter. Similarly reading a value of 12.34 will return a 32-bit integer value of 1234.

Table 8.8 PPO 4 Word OUT data structure

OUT data word	Function			
	b15-b12	b11	b10-b8	b7-b0
OUT word 0	TASK ID	0	MENU	
OUT word 1	PARAMETER		Reserved	
OUT word 2	DATA HIGH word			
OUT word 3	DATA LOW word			

The PPO 4 Word protocol is controlled by the TASK ID and RESPONSE ID; the TASK ID specifies the transaction required and the remainder of the data words carry the data for the transaction. Table 8.9 lists the possible TASK ID codes.

Table 8.9 TASK ID codes

TASK ID	Function	Description
0	No task	No non-cyclic transaction required
1	Fieldbus specific	
2	Fieldbus specific	
3	Fieldbus specific	
4	Not implemented	Reserved
5	Not implemented	Reserved
6	Request parameter value	Read parameter value from drive. Specify MENU and PARAMETER, set DATA HIGH word and DATA LOW word to 0.
7	Change parameter value (16-bit)	Write 16-bit parameter value to the drive. Specify MENU, PARAMETER and DATA LOW word. (Any value in DATA HIGH word will be discarded.) This function can be used to write to 32-bit drive parameters, but the range of values is limited to 16 bits.
8	Change parameter value (32-bit)	Write 32-bit parameter value to the drive. Specify MENU, PARAMETER, DATA HIGH word and DATA LOW word. This function can also be used to write to 16-bit drive parameters, but if DATA HIGH word is not set to 0, a value over-range error will be reported.
9	Request last parameter reference	Returns the last parameter for the specified menu. Specify MENU. (Values in PARAMETER, DATA HIGH word and DATA LOW word will be discarded.)

Table 8.10 shows the data structure of a PPO 4 Word response that will be returned by SM-PROFIBUS DP-V1.

Table 8.10 PPO 4 Word IN data structure

IN data word	Function			
	b15-b12	b11	b10-b8	b7-b0
IN word 0	RESPONSE ID	0	MENU	
IN word 1	PARAMETER			
IN word 2	DATA HIGH word			
IN word 3	DATA LOW word			

The RESPONSE ID indicates the success or otherwise of the requested transaction. Table 8.11 lists the possible RESPONSE ID codes.

Table 8.11 RESPONSE ID codes

RESPONSE ID	Function	Description
0	No task	No non-cyclic transaction active
1	Fieldbus specific	
2	Fieldbus specific	
3	Not implemented	
4	Transfer parameter value (16-bit)	Returns a 16-bit data value from the request parameter value specified by TASK ID 6, or the successful change parameter value (16-bit) specified by TASK ID 7.
5	Transfer parameter value (32-bit)	Returns a 32-bit data value from the request parameter value specified by TASK ID 6, or the successful change parameter value (32-bit) specified by TASK ID 8.
6	Transfer last parameter reference	Returns the highest parameter for the menu specified by request last parameter reference, TASK ID 9.
7	Error - TASK ID could not be executed	The previously specified TASK ID could not be completed. Word 3 will return an error code to indicate the reason for the TASK ID failure (see table below).
8	Error - read only parameter	Target parameter specified by TASK ID 7 or TASK ID 8 is read only, and cannot be modified.

If RESPONSE ID 7 has been received, the error code can be read from word 3. This will indicate the reason why the TASK ID request failed (see Table 8.12).

Table 8.12 PPO 4 Word error codes

ERROR CODE	Error	Description
0	Invalid menu	The specified menu does not exist.
1	Parameter is read only	The specified parameter is read only, and cannot be written to.
2	Value out of range	The specified data value is out of range for the parameter.
3	Invalid parameter / menu	The specified parameter does not exist.
18	Parameter error	No last parameter information available.

8.8.3 Reading parameters using PPO 4 Word mode

Figure 8-5 shows the sequence of events required to read a drive parameter using the PPO 4 Word non-cyclic channel.

Figure 8-5 PPO 4 Word Read sequence

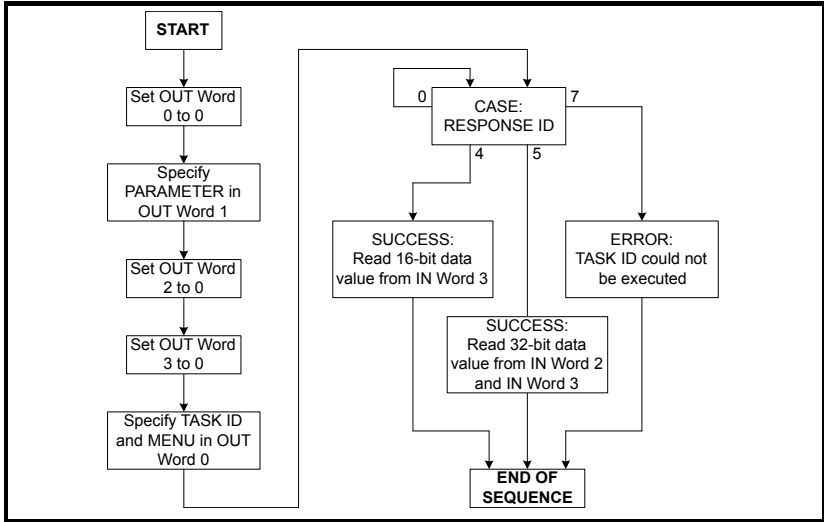

Table 8.13 shows the possible TASK ID and RESPONSE ID combinations that may be seen when attempting to read a parameter value from a drive.

Table 8.13 PPO 4 Word Read TASK ID and RESPONSE ID combinations

Function	TASK ID	RESPONSE ID	Message status
No Task	0	0	No message active.
Request Parameter Value (16-bit)	6	4	Parameter read successfully, 16-bit value returned in word 3.
Request Parameter Value (32-bit)	6	5	Parameter read successfully, 32-bit value returned in words 2 and 3.
Request Parameter Value (16-bit)	6	7	TASK ID 6 could not be executed. Check the error code in IN word 3 for the reason why.
Request Last (Parameter Reference)	9	6	The highest parameter reference in specified menu is available in IN word 3.
Request Last Parameter Reference	9	7	TASK ID 9 could not be executed. Check the error code in IN word 3 for the reason why.

Table 8.14 shows an example set of data words for PPO 4 Word mode. This example will read the value in the post ramp speed reference (Pr 2.01) in the drive.

Table 8.14 PPO 4 Word read request example

OUT data word	Hex value	Function			
		b15-b12	b11	b10-b8	b7-b0
OUT word 0	0x6002	TASK ID = 6	0	MENU = 2	
OUT word 1	0x0100	PARAMETER = 1		0	
OUT word 2	0x0000	DATA HIGH word = 0			
OUT word 3	0x0000	DATA LOW word = 0			

Table 8.15 shows an example successful read response to the read instruction illustrated above. The value returned is 15284, which equates to 1528.4 rpm.

Table 8.15 PPO 4 Word read response example

IN data word	Hex value	Function			
		b15-b12	b11	b10-b8	b7-b0
IN word 0	0x5002	RESPONSE ID = 5	0	MENU = 2	
IN word 1	0x0100	PARAMETER = 1		0	
IN word 2	0x0000	DATA HIGH word = 0			
IN word 3	0x3BB4	DATA LOW word = 15284			

NOTE

It is important that the correct module is selected from the GSD file to ensure that the PPO 4 word mode block is consistent otherwise data skew may occur.

If the OUT data words 0 and 1 are left at the same value, the target parameter will be read or written to (depending on the TASK ID) on every data cycle.

If the PPO 4 command is left in the data words, the read will be executed on every poll of the network, effectively providing a continuous read. Care should be taken to ensure the parameters for the read are setup before the TASK ID is changed from 0 to prevent incorrect data in the returned value.

8.8.4 Writing parameters using PPO 4 Word mode

Figure 8-6 shows the sequence of events required to write to a drive parameter using the PPO 4 Word non-cyclic channel.

Figure 8-6 PPO 4 Word write sequence

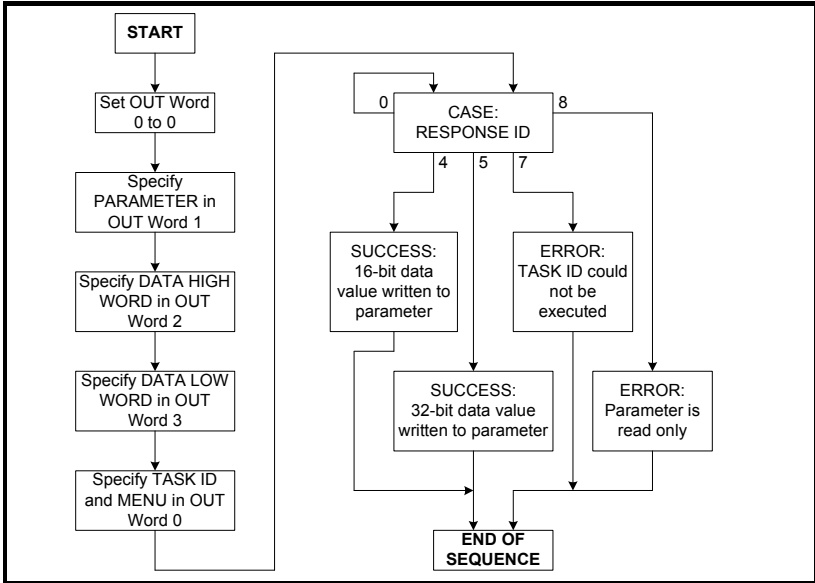

Table 8.16 shows the possible TASK ID and RESPONSE ID combinations that may be seen when attempting to write to the drive.

Table 8.16 PPO 4 Word write TASK ID and RESPONSE ID combinations

Function	TASK ID	RESPONSE ID	Message status
No Task	0	0	No message active.
Write Parameter Value (16-bit)	7	4	Parameter (16-bit) written successfully.
Write Parameter Value (32-bit)	8	5	Parameter (32-bit) written successfully.
Write Parameter Value (16-bit)	7	7	TASK ID 7 could not be executed. Check the error code in IN word 3 for the reason why.
Write Parameter Value (32-bit)	8	7	TASK ID 8 could not be executed. Check the error code in IN word 3 for the reason why.
Write Parameter Value (32-bit)	8	8	Parameter is read only, and cannot be written to.

Table 8.17 shows an example set of data words for PPO 4 Word mode. This example will write a value of 1553.9 rpm (32-bit value is 15539) to the digital speed reference 1 (Pr 1.21) to the drive.

Table 8.17 PPO 4 Word write request example

OUT data word	Hex value	Function			
		b15-b12	b11	b10-b8	b7-b0
OUT word 0	0x8001	TASK ID = 8	0	MENU = 1	
OUT word 1	0x1500	PARAMETER = 21		0	
OUT word 2	0x0000	DATA HIGH word = 0			
OUT word 3	0x3CB3	DATA LOW word = 15539			

Table 8.18 shows an example successful write response to the write instruction illustrated above in Table 8.17.

Table 8.18 PPO 4 Word write response example

IN data word	Hex value	Function			
		b15-b12	b11	b10-b8	b7-b0
IN word 0	0x5001	RESPONSE ID = 5	0	MENU = 1	
IN word 1	0x1500	PARAMETER = 21		0	
IN word 2	0x0000	DATA HIGH word = 0			
IN word 3	0x3CB3	DATA LOW word = 15539			

NOTE

If the PPO 4 command is left in the data words, the write will be executed on every poll of the network, effectively providing a continuous write. Care should be taken to ensure the parameters for the write are setup before the TASK ID is changed from 0 to prevent incorrect data being written.

9 Control and status words

9.1 What are control and status words?

The control and status words allow the digital control and monitoring of the drive to be implemented using a single data word for each function. Each bit in the control word has a particular function and provides a method of controlling the output functions of the drive, such as run and direction.

Each bit in the status word provides feedback about the drive's state of health and operational condition, such as drive ok, drive at speed, etc.

9.2 Control word

The SM-PROFIBUS DP-V1 control word consists of sixteen control bits some of which are reserved. See Table 9.1 for the individual bit function descriptions.

Table 9.1 Control word bit definitions

b15	b14	b13	b12	b11	b10	b9	b8
	KEYPAD WDOG	RESET	TRIP			JOG REV	REMOTE
b7	b6	b5	b4	b3	b2	b1	b0
AUTO	NOT STOP	RUN	FWD REV	RUN REV	JOG FWD	RUN FWD	ENABLE

To enable fieldbus control the fieldbus enable signal (Pr **6.43**) and the auto bit (bit7) must both be set to '1'. When the AUTO bit is reset to 0 the drive will revert to terminal control.

For safety reasons, the external HARDWARE ENABLE signal must be present before the fieldbus control word can be used to start the drive. This terminal is normally controlled by an external "Emergency Stop" circuit to ensure that the drive is disabled in an emergency situation.

The control word REMOTE bit directly controls the drive parameter Pr **1.42**, the function of which is to select the digital speed reference as the source of the drive's speed reference. When the REMOTE bit is reset to 0 the drive will revert to using the external analog speed reference.

The actual digital speed reference selected when REMOTE is set to 1 will be Pr **1.21**, which is also the default mapping for the fieldbus speed reference. However Pr **1.15** can be used to change which of the digital references is selected. For further details on the drive digital speed reference, please refer to the appropriate drive user guide.

Table 9.2 lists in detail the function of each control word bit. For further in-depth details about drive control words and sequencing bits please refer to the appropriate drive documentation.

NOTE When a trip occurs, the drive control word **MUST** be set to a safe, disabled state. This ensures that the drive does not re-start unexpectedly when it is reset. This can be achieved by continuously monitoring the drive status word, and interlocking it with the control word.

NOTE By default data compression is off and therefore the control word will be cast as 32-bit with bits 16 to 31 reserved.

Table 9.2 control word bit functions

Bit	Function	Description
0	ENABLE	Set to 1 to enable the drive. Resetting to 0 will immediately disable the drive, and the motor will coast to a stop. The external HARDWARE ENABLE signal must also be present before the drive can be enabled.
1	RUN FWD	Set to 1 (with ENABLE set to 1) to run the motor in the forward direction. When reset to 0, the drive will decelerate the motor to a controlled stop.
2	JOG FWD	Set to 1 to jog the motor forward. This signal needs to be used in conjunction with the ENABLE bit. This signal is overridden by a RUN, RUN REV or RUN FWD signal.
3	RUN REV	Set to 1 (with ENABLE set to 1) to run the motor in the reverse direction. When reset to 0, the drive will decelerate the motor to a controlled stop.
4	FWD REV	Set to 1 to select the reverse direction. Set to 0 to run in the forward direction. The RUN signal is used to start and stop the motor.
5	RUN	Set to 1 to run the motor. FWD REV is used to select the direction of motor rotation. When reset to 0, the drive will decelerate the motor to a controlled stop.
6	NOT STOP	Set to 1 to allow the sequencing bit to be latched. If NOT STOP is zero, all latches are cleared and held at 0. Pr 6.04 must be correctly set for this to function.
7	AUTO	Set to 1 to enable fieldbus control of the drive Control Word. The Control Word Enable (Pr 6.43) must also be set to 1. When reset to 0, the drive will operate under terminal control.
8	REMOTE	Set to 1 to select digital speed reference 1 (Pr 1.21), and reset to 0 to select analog reference 1 (Pr 1.36). REMOTE directly controls Pr 1.42 , so reference selector (Pr 1.14) and preset selector (Pr 1.15) must both be set to 0 (default) for the REMOTE bit to work properly.
9	JOG REV	Set to 1 to jog the motor in reverse. This signal needs to be used in conjunction with the ENABLE bit. This signal is overridden by a RUN/RUN REV/RUN FWD command.
10	Reserved	
11	Reserved	
12	TRIP	Set to 1 to trip the drive at any time. The trip display on drive will be CL.bit and the trip code will be 35. AUTO (b7) has no effect on this function. The trip cannot be cleared until TRIP is reset to 0.
13	RESET	A 0-1 transition of the RESET bit will reset the drive from a trip condition. If the reason for the trip is still present, or another fault condition has been detected, the drive will immediately trip again. When resetting the drive, it is recommended to check the status word to ensure that the reset was successful, before attempting to re-start the drive.
14	KEYPAD WDOG	This watchdog is provided for an external keypad or other devices where a break in the communication link must be detected. The watchdog system can be enabled and/or serviced if this bit is changed from zero to one while the control word enabled. Once the watchdog is enabled it must be serviced at least once every second or an SCL trip will occur. The watchdog is disabled when an SLC trip occurs, and so it must be re-enabled when the trip is reset.
15	Reserved	

9.3 Status word

The SM-PROFIBUS DP-V1 status word consists of sixteen control bits some of which are reserved. See Table 9.3 for the individual bit function descriptions.

Table 9.3 Status word bit definitions

b15	b14	b13	b12	b11	b10	b9	b8
Not Used	Mains Loss	Direction Running	Direction Set	Brake Alarm	Brake Active	Regen	Current Limit
b7	b6	b5	b4	b3	b2	b1	b0
Load Reached	Above Set Speed	At Set Speed	Below Set Speed	Running At Speed	Zero Speed	Drive Active	Drive ok

The fieldbus status word is mapped directly from the drive status word, Pr **10.40**.

Pr **10.40** is generated by the values of several individual drive status bits; Table 9.4 shows the function indicated by each bit in the status word when set to 1.

Table 9.4 Drive status word bit functions

Bit	Parameter	Description
0	Pr 10.01	bit 0 = 0: Drive not ok (tripped). bit 0 = 1: Drive ok.
1	Pr 10.02	Drive active When bit 1 = 1, the drive is in run mode.
2	Pr 10.03	Zero speed In Open Loop mode, zero speed indicates that the absolute value of the post-ramp speed reference is at or below the zero speed threshold. In Closed Loop and Servo modes, zero speed indicates that the absolute value of speed feedback is at or below the zero speed threshold.
3	Pr 10.04	Running at or below minimum speed In bipolar mode (Pr 1.10 = 1) Pr 10.04 is the same as zero speed, Pr 10.03 . (See above.) In unipolar mode, Pr 10.04 is set if the absolute value of the post-ramp speed reference (Pr 2.01) or speed feedback (Pr 3.02) is at or below minimum speed + 0.5Hz or 5rpm. (Minimum speed is defined by Pr 1.07 .) This parameter is only set if the drive is running.
4	Pr 10.05	Below set speed Only set if the drive is running at below set speed. Refer to Pr 3.06 , Pr 3.07 and Pr 3.09 in the drive documentation for more details.
5	Pr 10.06	At speed Only set if the drive is running at set speed. Refer to Pr 3.06 , Pr 3.07 and Pr 3.09 in the drive documentation.
6	Pr 10.07	Above set speed Only set if the drive is running at above set speed. Refer to Pr 3.06 , Pr 3.07 and Pr 3.09 in the drive documentation for more details.
7	Pr 10.08	Load reached Indicates that the modulus of the active current is greater or equal to the rated active current, as defined in menu 4. Refer to the drive documentation for more details.
8	Pr 10.09	In current limit Indicates that the current limits are active.

Table 9.4 Drive status word bit functions

Bit	Parameter	Description
9	Pr 10.10	Regenerating Unidrive SP, Affinity, Commander SK and Digitax ST: Indicates that power is being transferred from the motor to the drive. Mentor MP only: Indicates that power is being transferred from the drive to the supply. Regen mode (Unidrive SP only): Indicates that power is being transferred from the Unidrive SP to the supply.
10	Pr 10.11	Dynamic brake active Indicates that the braking IGBT is active. If the IGBT becomes active, this parameter will remain on for at least one second.
11	Pr 10.12	Dynamic brake alarm Dynamic brake alarm is set when the braking IGBT is active, and the braking energy accumulator is greater than 75%.
12	Pr 10.13	Direction commanded Direction commanded is set to 1 if the Pre-ramp speed reference (Pr 1.03) is negative and reset to 0 if the Pre-ramp speed reference is zero or positive.
13	Pr 10.14	Direction running A 0 indicates forward direction and a 1 indicates reverse direction. The source of this bit is Pr 2.01 for open loop mode and Pr 3.02 for closed loop and servo modes.
14	Pr 10.15	Mains loss (Not Mentor MP) Mains loss indicates that the drive has detected a mains loss from the level of the DC bus voltage. This parameter can only become active if mains loss ride through or mains loss stop modes are selected. Refer to Pr 6.03 in the <i>drive Advanced User Guide</i> for more details. <i>Unidrive SP only</i> - In regen mode, mains loss is the inverse of Pr 3.07. Refer to the <i>Unidrive SP Advanced User Guide</i> for more details.
15	Not Used	Reserved

10 Diagnostics

This section provides basic diagnostic information intended to enable resolution of the most common problems encountered when setting up a SM-PROFIBUS DP-V1 on a PROFIBUS-DP network.

A high percentage of problems reported are basic set-up problems that can be avoided by using the information in this chapter. Start by using the *Diagnostic flow chart* on page 62 to determine the possible cause of a problem. If after following the flow chart you are still experiencing problems please contact your supplier or local Control Techniques Drive Centre for support.

NOTE Please note that support will be limited to the setting up and networking of the drive.

10.1 Module ID code

Table 10.1 Module ID code

Pr MM.01	Default	403 (SM-PROFIBUS DP-V1)
	Range	0 to 499
	Access	RO

The module ID code indicates the type of module installed in to the slot corresponding to menu **MM**. The module ID code for SM-PROFIBUS DP-V1 is 403.

10.2 Module firmware version

Table 10.2 SM-PROFIBUS DP-V1 firmware - major version (xx.yy)

Pr MM.02	Default	N/A
	Range	00.00 to 99.99
	Access	RO

Table 10.3 SM-PROFIBUS DP-V1 firmware - minor version (zz)

Pr MM.51	Default	N/A
	Range	0 to 99
	Access	RO

Unidrive SP (Sizes 1 to 6) / Unidrive SPM / Mentor MP

The software version of the Solutions Modules can be identified by looking at Pr **15.02** or Pr **16.02** or Pr **17.02** and Pr **15.51** or Pr **16.51** or Pr **17.51**.

Menu 15,16 or 17 is Solutions Module slot dependent with menu 17 being the lowest position nearest the control terminal connections.

The software version takes the form of xx.yy.zz, where Pr **15.02** or Pr **16.02** or Pr **17.02** displays xx.yy and Pr **15.51** or Pr **16.51** or Pr **17.51** displays zz (e.g. for software version 01.01.00 on a module in the middle Solutions Module slot, Pr **16.02** will display 1.01 and Pr **16.51** will display 0).

Unidrive SP (Size 0) / Digitax ST / Unidrive ES / Affinity

The software version of the Solutions Modules can be identified by looking at Pr **15.02** or Pr **16.02** and Pr **15.51** or Pr **16.51**.

Menu 15 or 16 is Solutions Module slot dependent with menu 15 (Unidrive SP size 0 and Digitax ST) or menu 16 (Unidrive ES and Affinity) being the position nearest the control terminal connections.

The software version takes the form of xx.yy.zz, where Pr **15.02** or Pr **16.02** displays xx.yy and Pr **15.51** or Pr **16.51** displays zz (e.g. for software version 01.01.00 on a module in the middle Solutions Module slot (Unidrive ES and Affinity) or for Unidrive SP size 0 and Digitax ST, the Solutions Module slot nearest the incoming supply terminals), Pr **16.02** will display 1.01 and Pr **16.51** will display 0).

Commander SK (Sizes B to D and 2 to 6)

The software version of the Solutions Module can be identified by looking at Pr **15.02** and Pr **15.51**. The software version takes the form of xx.yy.zz, where Pr **15.02** displays xx.yy and Pr **15.51** displays zz (e.g. for software version 01.01.00 Pr **15.02** will display 1.01 and Pr **15.51** will display 0).

The full version of the SM-PROFIBUS DP-V1 firmware can be assembled by combining the major version (xx.yy) and the minor version (zz) as follows: xx.yy.zz.

10.3 PROFIBUS-DP node address

Table 10.4 PROFIBUS-DP node address

Pr MM.03	Default	126
	Range	0 to 126
	Access	RW

Each node on a PROFIBUS-DP network must be given a unique network node address. The SM-PROFIBUS DP-V1 must be re-initialized to make a change of node address active. Addresses 0 and 126 are reserved for system use and should not be used.

10.4 Network data rate

Table 10.5 Network data rate

Pr MM.04	Default	N/A
	Range	-1 to 9
	Access	RO

The SM-PROFIBUS DP-V1 will automatically detect the PROFIBUS-DP network data rate and synchronise to it. Pr **MM.04** will indicate the data rate that has been detected by the SM-PROFIBUS DP-V1.

A value of -1 indicates that the SM-PROFIBUS DP-V1 has not detected any activity on the PROFIBUS-DP network and is waiting for the master controller to start communicating.

NOTE The PROFIBUS-DP data rate parameter can be changed, but this will not affect the data rate at which the SM-PROFIBUS DP-V1 communicates. The data rate display will be updated when SM-PROFIBUS DP-V1 is re-initialized.

Table 10.6 Network data rate status

Pr MM.04	bits/s
-1	Auto-detecting
0	12M
1	6.0M
2	3.0M
3	1.5M
4	500k
5	187.5k
6	93.75k
7	45.45k
8	19.2k
9	9.6k

10.5 Data format

Table 10.7 Data format

Pr MM.05	Default	4
	Ranges	0-32,100-131& 200 to 228
	Access	RW

The default data format is four cyclic words, each cyclic data channel is mapped to a drive parameter.

NOTE The maximum number of 16-bit data words that is possible is thirty-two (in and out) with only cyclic data, thirty-one (in and out) with Mode 1 non-cyclic data and twenty-eight (in and out) with PPO4 word mode.

10.6 Operating status

Table 10.8 Operating status

Pr MM.06	Default	N/A
	Range	-3 to 9999
	Access	RO

The operating status of the SM-PROFIBUS DP-V1 can be viewed in the operating status parameter (Pr **MM.06**). When the SM-PROFIBUS DP-V1 is communicating successfully with the PROFIBUS-DP master controller, Pr **MM.06** will give an indication of the number of cyclic data messages that are being processed per second.

Table 10.9 PROFIBUS-DP operating status codes

Pr MM.06	Parameter	Description
>0	Network ok	Indicates the number of processed cyclic messages per second.
0	Network ok, No Data Transfer	Indicates that the PROFIBUS-DP master has established communications with the SM-PROFIBUS DP-V1. If operating status changes briefly to -1 and returns to 0, the slave configuration does not match the configuration in the master controller.
-1	Initialised	Indicates that the SM-PROFIBUS DP-V1 has initialized correctly, and is waiting for the PROFIBUS-DP master to initialize communications.
-2	Internal Hardware Failure	Indicates that part of the SM-PROFIBUS DP-V1 initialisation sequence was not successful. If this fault persists after a power cycle, replace the SM-PROFIBUS DP-V1.
-3	Configuration Error	Indicates an invalid setting in the SM-PROFIBUS DP-V1 configuration parameters.

If a mapping configuration error or network error is detected the drive may trip. Refer to section 10.8 *Drive trip display codes* on page 60 for details about the drive trip display.

10.7 Mapping status

Table 10.10 SM-PROFIBUS DP-V1 mapping status

Pr MM.49	Default	0
	Range	0 to 255
	Access	RO

If the SM-PROFIBUS DP-V1 operating status parameter (Pr **MM.06**) indicates a value of -3, a mapping configuration error has been detected. The reason for the error is indicated by the SM-PROFIBUS DP-V1 mapping status parameter, Pr **MM.49**.

When a mapping error has been corrected, re-initialize the SM-PROFIBUS DP-V1 by setting Pr **MM.32** to ON (1).

The mapping error codes are described in Table 10.11.

Table 10.11 Mapping error codes

Mapping status	Error	Description
0	No error detected	No error detected with IN or OUT cyclic data mapping configuration.
2	Direct data mapping error	Non-cyclic data cannot be used when direct data mapping is enabled.
3	Invalid non-cyclic mode	An invalid non-cyclic data mode has been selected in Pr MM.05 .
5	Invalid mode value	The value entered in Pr MM.05 is not supported.
30	Configuration error	After expanding ranges of block mappings, too many OUT cyclic data channels configured.
31	PPO error	Total size of all OUT cyclic data mappings has exceeded the total size of the cyclic data.
32	PPO and data format error	More than ten cyclic OUT data channels have been selected with direct data mapping mode.
33	Data compression disabled with PPO	After expanding ranges of block mappings, too many OUT cyclic data channels configured.
104	Multiple non-cyclic mapping error	A non-cyclic data mode has been mapped more than once in the IN data mapping configuration parameters (Pr MM.10 to Pr MM.19).

Table 10.11 Mapping error codes

Mapping status	Error	Description
110	Configuration read error	An error has occurred reading the IN cyclic data mapping configuration parameters from the drive. (Pr MM.10 to Pr MM.19)
111	Invalid source parameter	One or more parameters specified in the IN cyclic data mapping configuration (Pr MM.10 to Pr MM.19) is outside of the allowed range for PROFIBUS-DP. The allowable parameter range is from 0.00 to 199.99
112	Read mismatch	One or more parameters specified in the IN cyclic data mapping configuration (Pr MM.10 to Pr MM.19) cannot be used as a source parameter for IN data. The parameter may not exist.
113	Hole in IN data mapping configuration	IN cyclic data mapping parameters are not contiguous, (Pr MM.10 to Pr MM.19). It is not possible to have an unused parameter in the middle of the cyclic data.
115	Inter-option communications error	A request to set up an inter-option communications block failed. Either the server does not support block transfer or parameters were not legal.
120	Too many IN data objects mapped	After expanding ranges of block mappings, too many IN cyclic data channels configured.
121	Mapping over length	Total size of all IN cyclic data mappings has exceeded the total size of the cyclic data.
122	Register mode objects exceeded	More than ten cyclic IN data channels have been selected with direct data mapping mode.
204	Multiple non-cyclic mapping error	A non-cyclic data mode has been mapped more than once in the OUT cyclic data mapping configuration parameters (Pr MM.20 to Pr MM.29)
210	Configuration read error	An error has occurred reading the OUT cyclic data mapping configuration parameters from the drive (Pr MM.20 to Pr MM.29).
211	Invalid destination parameter	One or more parameters specified in the OUT cyclic data mapping configuration is outside of the allowed range for PROFIBUS-DP (Pr MM.20 to Pr MM.29). The allowable parameter range is from 0.00 to 199.99
212	Write mismatch	One or more parameters specified in the OUT cyclic data mapping configuration (Pr MM.20 to Pr MM.29) cannot be used as a destination parameter for OUT data. The parameter may not exist, or is a read-only parameter. This error will also occur if an attempt is made to map OUT data to the configuration parameters of a fieldbus option in another slot, unless that fieldbus is configured in register mode, i.e. Pr MM.09 = ON (1).
213	Hole in OUT data mapping configuration	OUT data mapping parameters are not contiguous (Pr MM.20 to Pr MM.29). It is not possible to have an unused parameter in the middle of the cyclic data.
214	Duplicate mapping error	Two or more OUT cyclic data mapping configuration parameters (Pr MM.20 to Pr MM.29) have been configured with the same destination parameter reference.
215	Inter-option communications error	A request to set up an inter-option communications block failed. Either the server does not support block transfer or parameters were not legal.

Safety information
Introduction
Mechanical installation
Electrical installation
Getting started
ESD
Cyclic data
Non-cyclic data
Control and status words
Diagnostics
PROFIdrive profile (V4)
Advanced features
Legacy features
Quick reference
Glossary of terms
Index

Table 10.11 Mapping error codes

Mapping status	Error	Description
220	Too many OUT data objects mapped	After expanding ranges of block mappings, too many OUT cyclic data channels configured.
221	Mapping over length	Total size of all OUT cyclic data mappings has exceeded the total size of the cyclic data.
222	Register mode objects exceeded	More than ten cyclic OUT data channels have been selected with direct data mapping mode.

10.8 Drive trip display codes

If the SM-PROFIBUS DP-V1 detects an error during operation, it will force a trip on the drive. However, the trip code displayed on the drive will only indicate which slot initiated the trip. The exact reason for the trip will be indicated in the SM-PROFIBUS DP-V1 error code parameter, Pr **MM.50**.

Table 10.12 shows the possible trip codes that will be displayed on the drive when a problem is detected with the SM-PROFIBUS DP-V1 or when the SM-PROFIBUS DP-V1 initiates a trip.

Table 10.12 Drive trip display codes

Trip Code	Fault	Description
SLX.HF	Hardware fault	The drive has detected that a Solutions Module is present, but is unable to communicate with it.
SLX.Er	Error	User trip generated by the SM-PROFIBUS DP-V1
SLX.nF	Not installed	This trip will occur if a drive slot was previously configured with an options module but on power up, no options module was detected.
SLX.dF	Different module installed	The slot configuration parameters stored in the drive are not valid SM-PROFIBUS DP-V1 configuration parameters. This trip will also occur if an SM-PROFIBUS DP-V1 module is installed to a previously unused slot.

NOTE Commander SK will show SL.Er without a slot number.

10.9 Module error code

Table 10.13 Module error code

Pr MM.50	Default	N/A
	Range	0 to 255
	Access	RO

If the SM-PROFIBUS DP-V1 detects an error during operation, it will force a trip on the drive and update the error code parameter, Pr **MM.50**. Table 10.14 shows the possible SM-PROFIBUS DP-V1 error codes

Table 10.14 SM-PROFIBUS DP-V1 error codes

Error code	Fault	Description
0	No error detected	Indicates that the SM-PROFIBUS DP-V1 module is ok. It is possible to trip the drive externally via various communication channels.
52	User control word trip	The TRIP bit has been set in the drive control word.
61	Configuration error	An invalid configuration has been detected. Refer to Pr MM.49 for mapping error codes.
65	Network loss	No new messages have been received for the specified network loss trip time.
66	Critical link failure	Internal error
70	Flash transfer error	The SM-PROFIBUS DP-V1 was unable to upload the configuration parameters from its flash memory to the drive.
71	Invalid fieldbus specific data	SM-PROFIBUS DP-V1 has detected an invalid data record. E.g. the stored I&M data has an invalid checksum.
74	SM-PROFIBUS DP-V1 overtemperature	If the temperature inside the SM-PROFIBUS DP-V1 exceeds 82°C, the SM-PROFIBUS DP-V1 will trip the drive.
80	Inter-option communication error	An inter-option communications time-out has occurred, but SM-PROFIBUS DP-V1 is unable to determine the reason for the error.
81	Communication error to slot 1	(Not Commander SK) Direct communications between the SM-PROFIBUS DP-V1 and an SM-Applications in another slot has timed out.
82	Communication error to slot 2	
83	Communication error to slot 3	
97	Firmware incompatible	The hardware revision level does not support the installed firmware version. If DP-V1 functionality is required then replace the module with a DP-V1 compatible module. If DP-V1 functionality is not required then install firmware version V03.01.01 or earlier.
98	Internal watchdog error	Internal error. Cycle power to the drive to reset from this trip. If trip persists, replace the SM-PROFIBUS DP-V1.
99	Internal software error	

10.10 Module serial number

Table 10.15 Module serial number

Pr MM.35	Default	N/A
	Range	32-bit
	Access	RO

The serial number is loaded into the SM-PROFIBUS DP-V1 during manufacture and cannot be changed. It contains the last six digits of the ten digit serial number on the label.

10.11 Troubleshooting

In order to assist in configuring the network, the *Diagnostic flow chart* on page 62 could be used.

Figure 10-1 Diagnostic flow chart

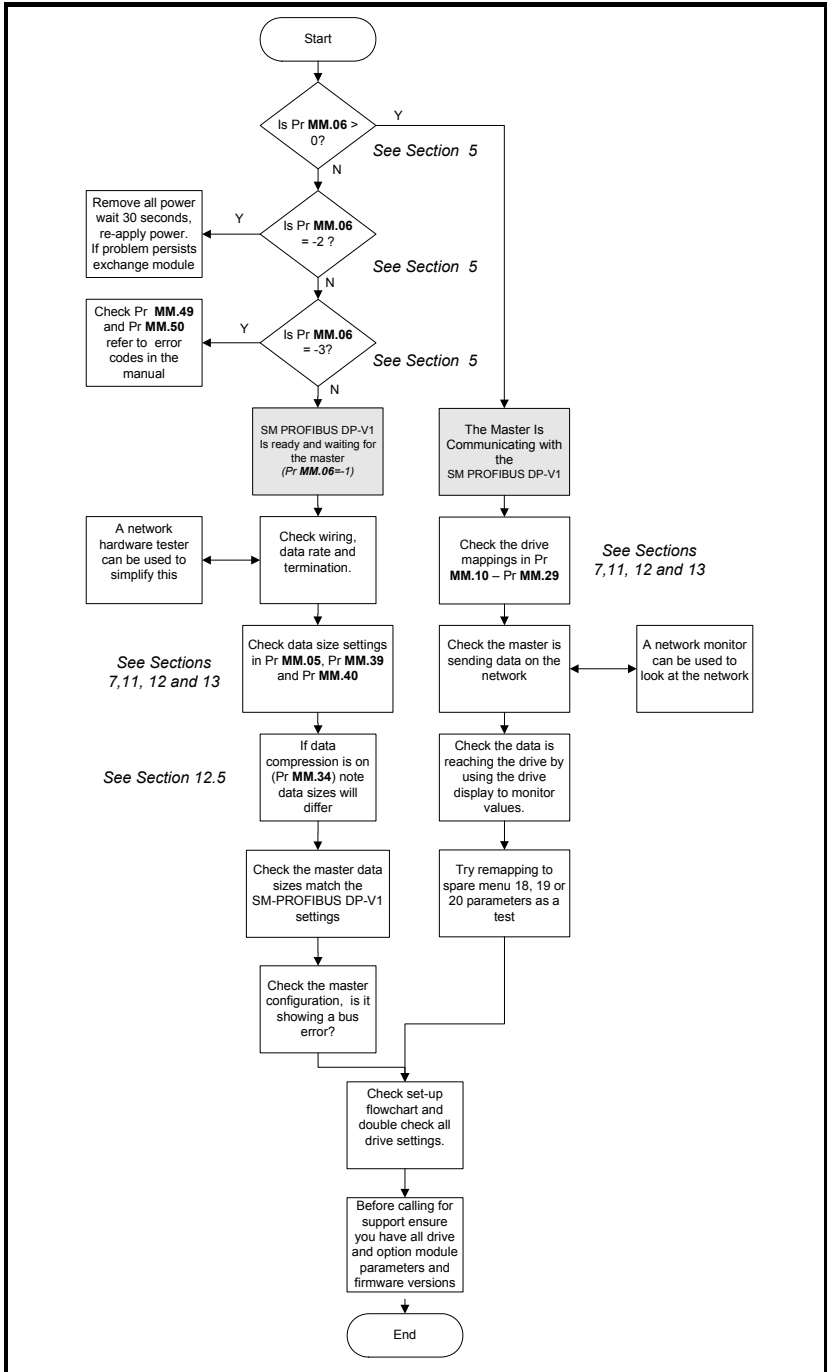

11 PROFIdrive profile (V4)

11.1 What is PROFIdrive profile?

The PROFIdrive profile is a non-vendor specific standard for controlling drives. PROFIdrive allows compatible drives from different vendors to be controlled and monitored using the same control strategy.

For further details of the PROFIdrive profile refer to the official PROFIBUS web-site at www.profibus.com.

This section relates to the PROFIdrive profile V4, for information on legacy support of the PROFIdrive profile V2, refer to section 13 *Legacy features* .

The SM-PROFIBUS DP-V1 module provides support for the “Standard Drive” application class 1 defined in the PROFIdrive V4 specification for speed control mode using Standard Telegram 1.

NOTE SM-PROFIBUS DP-V1 must be installed with V01.00.03 firmware (or later) to support the legacy PROFIdrive profile V2 (see section 13 *Legacy features*) and V03.02.00 to support the DP-V1 PROFIdrive profile V4 features.

SM-PROFIBUS DP-V1 supports the following PROFIdrive features:

- Standard Telegram 1
- PROFIdrive PNU Access
- Drive Identification
- Fault Buffer
- Identification and Maintenance Functions

11.2 Standard Telegram 1

This telegram is equivalent to the PPO3 mode in the legacy PROFIdrive profile, see section 13.2.3 *PPO 3* .

To select the Standard Telegrams for DP-V1, the following sequence must be performed:

- Set Pr **MM.05** to 0 to disable normal data format.
- Set Pr **MM.34** to 'ON' to enable data compression.
- Set Pr **MM.38** to the required number.
 - 6 for Standard Telegram 1.
 - 7 for Standard Telegram 1 with four cyclic words.
 - 8 for Standard Telegram 1 with eight cyclic words.
- Configure the mapping parameters as required.
- Pr **MM.32** set to 'ON' to re-initialise SM-PROFIBUS DP-V1.
- Check Pr **MM.06** is not a value of -3 (see section 10 *Diagnostics* for further details).
- Save drive parameters (refer to relevant drive documentation for more information).

NOTE Pr **MM.32** will automatically revert to 'OFF' after re-initialising. Re-initialising will cause the SM-PROFIBUS DP-V1 to temporary go off-line from the PROFIBUS-DP network.

NOTE

Once the PROFIdrive profile has been configured the corresponding mapping parameter will display a value of -1 and will be locked; only the user configurable mapping parameters will be editable.

The Standard Telegram 1 support is a mandatory requirement for Application Class 1 devices, the mapping structure is shown Table 11.1.

Table 11.1 Standard Telegram 1 - mapping structure

IN Data	Function	OUT Data	Function
word 0	PROFIdrive status word	word 0	PROFIdrive control word
word 1	Main Actual Value	word 1	Main Setpoint

In addition to the Standard Telegram 1, SM-PROFIBUS DP-V1 provides two other profiles with either four or eight cyclic words possible. Table 11.2 shows the profile with four cyclic words and Table 11.3 shows the profile with eight cyclic words.

Table 11.2 Standard Telegram 1 plus four cyclic words - mapping structure

IN Data	Function	OUT Data	Function
word 0	PROFIdrive status word	word 0	PROFIdrive control word
word 1	Main Actual Value	word 1	Main Setpoint
word 2	User configurable mapping using Pr MM.12 to Pr MM.15	word 2	User configurable mapping using Pr MM.22 to Pr MM.25
word 3		word 3	
word 4		word 4	
word 5		word 5	

Table 11.3 Standard Telegram 1 plus eight cyclic words - mapping structure

IN Data	Function	OUT Data	Function
word 0	PROFIdrive status word	word 0	PROFIdrive control word
word 1	Main Actual Value	word 1	Main Setpoint
word 2	User configurable mapping using Pr MM.12 to Pr MM.19	word 2	User configurable mapping using Pr MM.22 to Pr MM.29
word 3		word 3	
word 4		word 4	
word 5		word 5	
word 6		word 6	
word 7		word 7	
word 8		word 8	
word 9		word 9	

11.3 Main Setpoint

Main Setpoint is the speed reference defined in the PROFIdrive profile.

It is scaled such that -32768 to +32767 is -200% to +200% of the maximum speed clamp (Pr 1.06). The converted value is then written to drive digital speed reference 1 (Pr 1.21).

The formula used for this conversion is:

$$\text{Pr 1.21} = \frac{\text{Main Setpoint} \times \text{Max Speed Clamp}}{16384}$$

Example 1 - Open loop drive

The drive maximum speed clamp (Pr 1.06) = 50Hz

The main setpoint value sent from the master to the drive is 13107

Giving:

$$\text{Pr 1.21} = \frac{13107 \times 50}{16384} = 40.0\text{Hz}$$

Example 2 - Closed loop / servo drive

The drive maximum speed clamp (Pr 1.06) = 1500 rpm

The main setpoint sent from the master to the drive is 10923

Giving:

$$\text{Pr 1.21} = \frac{10923 \times 1500}{16384} = 1000\text{rpm}$$

11.4 Main Actual Value

Main Actual Value is the speed feedback reference defined in the PROFIdrive profile.

It is scaled such that -32768 to +32767 is -200% to +200% of the maximum speed clamp (Pr 1.06). The converted value is derived from:

- Pr 2.01 for open loop drive operation.
- Pr 3.02 closed loop or servo drive operating modes.

The formula used for this conversion is:

$$\text{Main Actual Value} = \frac{SF \times 16384}{\text{Max Speed Clamp}}$$

Where *SF* is the speed feedback parameter, i.e. Pr 2.01 or Pr 3.02 depending upon the drive operating mode.

Example 1 - Open loop drive

The drive maximum speed clamp (Pr 1.06) = 50Hz

The drive post ramp reference (Pr 2.01) = 35 Hz

Giving:

$$\text{MAV} = \frac{35 \times 16384}{50} = 11469$$

Example 2 - Closed loop / servo drive

The drive maximum speed clamp (Pr 1.06) = 1500 rpm

The main setpoint sent from the master to the drive is 10923

Giving:

$$\text{MAV} = \frac{1250 \times 16384}{3000} = 1000\text{rpm}$$

Safety Information
Introduction
Mechanical Installation
Electrical Installation
Getting started
GSD Files
Cyclic data
Non-cyclic data
Control and status words
Diagnostics
PROFIdrive profile (MA)
Advanced features
Legacy features
Quick reference
Glossary of terms
Index

11.5 PROFIdrive (V4) State Machine

The PROFIdrive profile V4.0 state machine is implemented for all DP-V1 Standard Telegrams, the operation of the state machine differs between the V2.0 of the PPO telegrams and the V4.0 of the DP-V1 Standard Telegrams.

This section relates to the V4.0 state machine only, for information on the V2.0 state machine see section 13.8 *PROFIdrive (V2) state machine diagram*.

The general state machine diagram (V4.0) is shown Figure 11-1.

The Speed Control state machine is shown in Figure 11-2.

The correct sequence of operation must be used for the state machine otherwise the message will be rejected and the entire sequence must be restarted. The only exception to this rule is when moving from state S2, it is possible to bypass state S3 and jump to state S4 directly.

11.6 Normal Run Sequence

The following sequence can be used to get the motor turning (all bit values refer to the PROFIdrive control word):

- Enable network control (bit 10 = 1, 0x0400)
- Remove all STOP commands (bits 1 & 2 = 1, 0x0406: S1 to S2)
- Set drive to Ready (bit 0 = 1, 0x0407: S2 to S3)
- Enable operation (bit 3 = 1, 0x040F: S3 to S4)
- Enable ramp function generator (bit 4 = 1, 0x041F)
- Unfreeze ramp function generator (bit 5 = 1, 0x043F)
- Enable setpoint value (bit 6 = 1, 0x047F)
- Set the main setpoint value in word 1 (Pr 1.21)

The motor should now accelerate to the speed set by the main setpoint value.

In order to stop the motor, the following options are available:

- Stop the motor using the drive ramp function: set bit 0 to OFF (0x047E) or
- Stop the motor and coast to zero speed: set bit 1 to OFF (0x047D) or
- Stop the motor using 'Quick stop': set bit 2 to OFF (0x047B)
- Disable drive: set bit 3 to OFF (0x0477)

There is a priority control hierarchy when more than the one stop command is given, these priorities are shown in the general state machine diagram and summarized in Table 11.4.

Table 11.4 Stop command priority

Priority	Control Word Bit	Stop Command
3 (highest)	1	Coast stop
2 (high)	2	Quick stop (Pr 2.22)
1 (low)	0	Ramp stop (Pr 2.21)
0 (lowest)	3	Disable Operation

NOTE When the network compatibility mode is used (Pr MM.41 = 1 or 2), DP-V1 functionality and the PROFIdrive (V4) profiles will not be available.

NOTE The deceleration rates are set in Pr 2.21 and Pr 2.22 for Ramp Stop and Quick Stop respectively.

Figure 11-1 PROFdrive V4 General State Machine Diagram

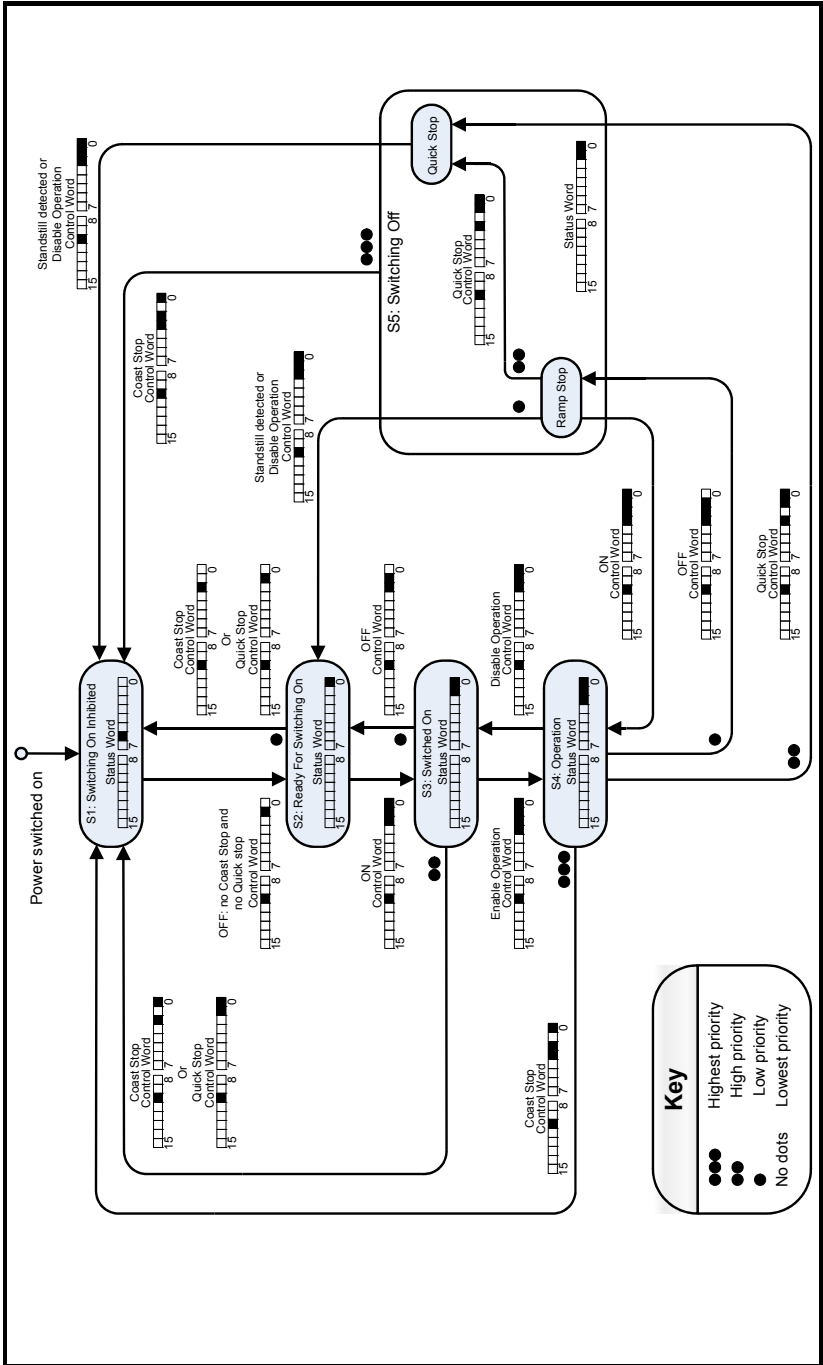

Safety Information
Introduction
Mechanical Installation
Electrical Installation
Getting started
Files
Cyclic data
Non-cyclic data
Control and status words
Diagnostics
PROFdrive profile (V4)
Advanced features
Legacy features
Quick reference
Glossary of terms
Index

Figure 11-2 PROFIdrive V4 Speed Control State Machine

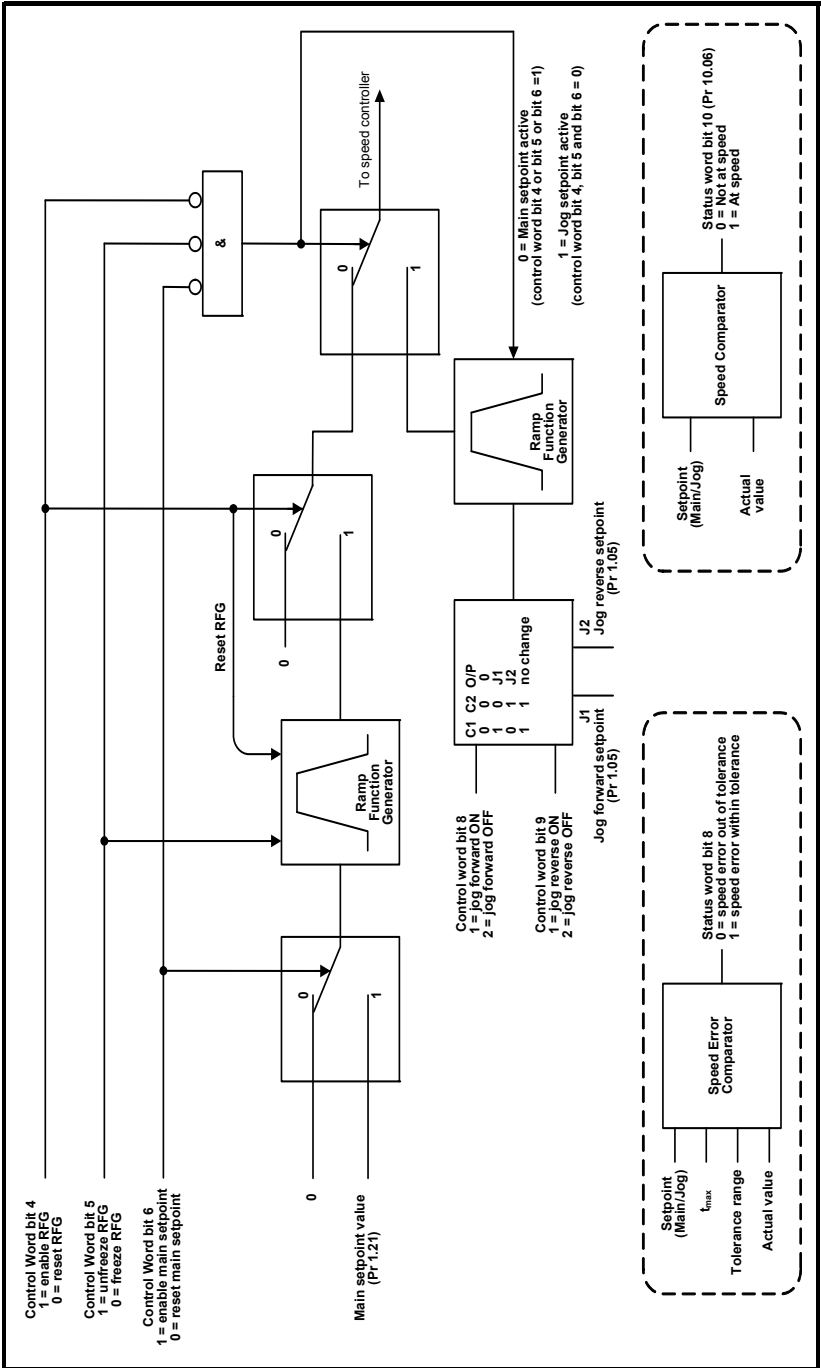

11.7 Stopping the motor using PROFDrive

There are four methods of stopping the motor, these are:

- Disable Operation (control word bit 3) - Drive is inhibited, motor coasts down to zero speed, status set to 'Switched On'.
- Ramp Stop (control word bit 0) - Motor decelerates under ramp control using deceleration rate1 (Pr **2.21**), drive is inhibited, status set to 'Ready For Switching On'.
- Quick Stop (control word bit 2) - Motor decelerates under ramp control using deceleration rate2 (Pr **2.22**), drive is inhibited, status set to 'Switching On Inhibited'.
- Coast Stop (control word bit 1) - Drive is inhibited, motor coasts down to zero speed, status set to 'Switching On Inhibited'.

11.8 Jogging

In order to use the jogging functions, the drive must be in the operational state (S4) and at standstill and each of the three bits (4, 5 and 6) of the control word must be set to a 0, if any of these three bits are set to a 1 and the drive is at standstill then the jogging functions are disabled and the main setpoint reference is used. The three control bits (4, 5 and 6) have no effect when in jog mode.

To leave jog mode, both jog bits (8 and 9) must not be active and the drive must be at standstill, the normal control bits (4, 5 and 6) will then be active.

The jog direction is controlled by bit 8 (forward) and bit 9 (reverse) of the control word as illustrated in Figure 11-2.

NOTE The jog setpoint is set in Pr **1.05**.

NOTE If both jog forward and jog reverse setpoints are selected at the same time (bits 8 and 9 are both set to a 1) then there will be no change to the jog direction. (i.e. if jog forward was previously selected then the motor will continue to jog forward, and if jog reverse was previously selected then the motor will continue to jog in the reverse direction).

The following sequence can be used to jog the motor in the forward direction:

- Enable network control (bit 10 = 1, 0x0400)
- Remove all STOP commands (bits 1 & 2 = 1, 0x0406: S1 to S2)
- Set drive to Ready (bit 0 = 1, 0x0407: S2 to S3)
- Enable operation (bit 3 = 1, 0x040F: S3 to S4)
- Set jog direction forward (bit 8=1 and bit 9=0, 0x050F) or
- Set jog direction reverse (bit 8=0 and bit 9=1, 0x060F)
- Set jog setpoint value (Pr **1.05**)

The motor should now jog at the speed set by the jog setpoint value.

11.9 PROFdrive control word

The PROFdrive control word consists of sixteen control bits some of which are reserved.

Table 11.5 PROFdrive control word bit functions

Bit	Value	Function	Description
0	1	No Ramp Stop	Ramp Stop command is withdrawn.
	0	Ramp Stop	The motor decelerates under ramp control using deceleration rate1 (Pr 2.21); inhibits the drive and go to 'Ready For Switching On' state.
1	1	No Coast Stop	Coast Stop command is withdrawn.
	0	Coast Stop	Voltage disconnected; inhibit the drive output stage. Main contactor is de-energized (if available), and the drive goes into the 'Switching On Inhibited' status: Motor coasts down
2	1	No Quick Stop	Quick Stop command is withdrawn.
	0	Quick Stop	The motor decelerates under ramp control using deceleration rate2 (Pr 2.22); inhibits the drive and go to 'Switching On Inhibited' state.
3	1	Enable Operation	Enable the drive and accelerate to the specified setpoint.
	0	Disable Operation	Inhibit the drive. Drive coasts down (ramp-function generator to zero or tracking), and into the Switched On' status.
4	1	Enable RFG	Enables the ramp function generator output.
	0	Reset RFG	Ramp function generator output is set to zero. Main contactor remains in, the drive is not isolated from the supply, drive ramps down along the current limit or at the DC bus voltage limit.
5	1	Unfreeze RFG	Unfreezes the ramp function generator output.
	0	Freeze RFG	Freezes the current setpoint from the ramp function generator.
6	1	Enable Setpoint	Selected value at the ramp function generator input is switched in.
	0	Inhibit Setpoint	Selected value at the ramp function generator input is set to 0.
7	1	Fault Acknowledge	Group signal is acknowledged at a positive edge; the drive is in the 'fault' status until the fault has been removed and then goes into 'switch-on inhibit' state.
	0	No meaning	
8	1	JOG1 ON	Prerequisite: Operation is enabled and Main Setpoint=0. The drive accelerates as fast as possible to jogging setpoint (Pr 1.05) in the forward direction.
	0	JOG1 OFF	The drive brakes as fast as possible along the RFG, if 'JOG1' was previously ON, and goes into 'operation enabled' at standstill.
9	1	JOG2 ON	Prerequisite: Operation is enabled and Main Setpoint=0. The drive accelerates as fast as possible to jogging setpoint (Pr 1.05) in the reverse direction.
	0	JOG2 OFF	The drive brakes as fast as possible along the RFG, if 'JOG2' was previously ON, and goes into 'operation enabled' at standstill.
10	1	Network control	Control from the PROFIBUS-DP network, process (cyclic) data is valid.
	0	No control	Process data invalid. Last received valid process data values are retained.
11-15	0	Reserved	

11.10 PROFdrive status word

Table 11.6 gives the description of each bit in the PROFdrive status word.

Table 11.6 PROFdrive status word bit functions

Bit	Value	Function	Comments
0	1	Ready to switch on	Power supply switched on, the drive is inhibited.
	0	Not ready to switch on	Power supply switched off.
1	1	Ready To Operate	Drive is ready to run.
	0	Not Ready To Operate	Drive is not ready to run.
2	1	Operation Enabled	Drive is operational.
	0	Operation Disabled	Drive is not operational.
3	1	Fault Present	Drive faulted, and thus not operational, goes into the switch-on inhibit status after acknowledgment and the fault has been removed. Fault number in the fault parameter.
	0	No Fault Present	Drive ok
4	1	Coast Stop Not Activated	Coast Stop command is not active.
	0	Coast Stop Activated	Coast Stop command is active.
5	1	Quick Stop Not Activated	Quick Stop command is not active.
	0	Quick Stop Activated	Quick Stop command is active.
6	1	Switch-on Inhibited	Power supply switched on, the drive is inhibited.
	0	Switch-on Not Inhibited	Power supply switched on,
7	1	Warning Present	Not Implemented
	0	No Warning Present	Not Implemented
8	1	Speed Error Within Tolerance	'At Speed' (Pr 10.06) = 1
	0	Speed Error Out Of Tolerance	'At Speed' (Pr 10.06) = 0
9	1	Control Requested	The automation system is requested to accept control.
	0	No Control Requested	Control only possible on the device itself.
10	1	Speed Or Frequency Reached/Exceeded	'At Speed' (Pr 10.06) = 1 or 'Above Set Speed' (Pr 10.07) = 1
	0	Speed Or Frequency Not Reached	'At Speed' (Pr 10.06) = 0 and 'Above Set Speed' (Pr 10.07) = 0
11-15	0	Reserved	

Safety Information
Introduction
Mechanical Installation
Electrical Installation
Getting started
GSD Files
Cyclic data
Non-cyclic data
Control and status words
Diagnostics
PROFdrive profile (V4)
Advanced features
Legacy features
Quick reference
Glossary of terms
Index

11.11 PROFdrive PNU access

PROFdrive parameters (PNUs) may be accessed by placing the PNU number in the Parameter Index field and any sub-index value should be placed in the Sub-index field of the PROFdrive request.

The full list of supported PROFdrive PNUs is shown in Table 11.7.

Table 11.7 Supported PROFdrive PNUs

PNU	Designation	Data type	Access	Explanation
918	Profibus Node ID	Unsigned16	RO	Returns the SM-PROFIBUS DP-V1 network node address.
922	Telegram selection	Unsigned16	RO	Returns the currently selected telegram
944	Fault message counter	Unsigned16	RO	Incremented by one when the fault buffer changes
947	Fault number	Array(n) Unsigned16	RO	Contains the fault numbers of the recorded faults (see Table 11.8 <i>Fault Buffer Associated PNUs</i> on page 74)
950	Fault buffer scaling	Array(n) Unsigned16	RO	Defines the number of fault situations and the number of faults per situation
964	Drive Unit ID	Array(n) Unsigned16	RO	Identifies the drive unit
965	Profile ID	Unsigned16	RO	Identifies the PROFdrive profile version
967	Control Word	Unsigned16	WO	Directly maps to the PROFdrive control word
968	Status Word	Unsigned16	RO	Directly maps to the PROFdrive status word
974	Parameter Access Identification	Array(n) Unsigned16	RO	Parameter channel request lengths
975	Drive Object ID	Array(n) Unsigned16	RO	Identifies the drive object
978	List of all DO-IDs	Array(n) Unsigned8	RO	Returns a list of all axis IDs
980-989	Defined parameters list	Array(n) Unsigned16	RO	Each PNU in the range contains an array of PNUs and drive parameters available. Only PNU980 is used and contains an array of parameters starting with the PROFdrive PNUs (excluding PNU980-989) followed by the drive parameters. The array elements are assigned in increasing sequence and consecutively. If an element contains a value of zero then the end of the list has been reached. The array elements are read starting at 0 in increments of 59 elements

NOTE

It is beyond the scope of this document to provide information on the Profibus DP-V1 message frame and PROFdrive PNUs. For more information please refer to the Profibus web-site www.profibus.com or contact your local Control Techniques Drive Centre.

11.12 Fault Buffer

The fault buffer provides a list of acknowledged and unacknowledged faults, the buffer contains eight elements numbered from 0 to 7, of which the first element (0) contains the active fault (if any). The remaining elements (1 to 7) contain the acknowledged faults in reverse order of occurrence, and therefore element 1 is the most recent acknowledged fault (last fault) and element 7 is the oldest acknowledged fault (first fault).

Acknowledged faults are faults which have been cleared by resetting the drive when a fault is acknowledged; the fault number will be placed in element 1 of the buffer, any existing recorded faults will be moved up (numerically) one element.

If element 7 already contains a fault number then this will be over-written with the value from position 6, the existing fault number is subsequently lost.

Unacknowledged faults are faults which have not been cleared, currently Control Techniques drives only support one fault of this type, the active fault in Pr 10.20.

The PROFIdrive fault buffer mechanism is shown in Figure 11-3.

Figure 11-3 DP-V1 Fault Buffer

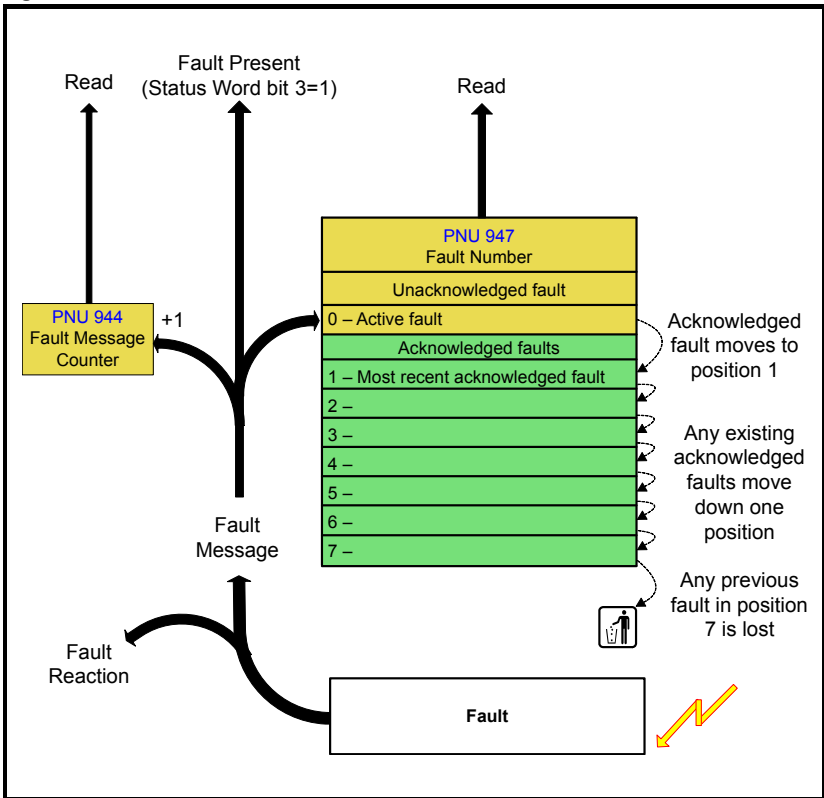

Table 11.8 Fault Buffer Associated PNUs

PNU	Designation	Description	
944	Fault message counter	Incremented by one when the fault buffer changes	
947	Fault number	Contains the fault numbers of the recorded faults	
		Element	Description
		0	Last unacknowledged fault (Pr 10.20)
	1 to 7	Acknowledged faults in reverse order of occurrence	
950	Fault buffer scaling	Defines the number of fault situations and the number of faults per situation. (factory set to 8 and 1 respectively)	

NOTE The fault buffer contents are stored in internal memory and will be cleared on a module reset or power-down.

11.13 Drive Identification

The PROFIdrive specification specifies certain objects that allow network tools to obtain information on the features supported by the slave.

SM-PROFIBUS DP-V1 supports the following PNUs for this purpose.

Table 11.9 Identification PNUs

PNU	Designation	Description
964	Drive Unit Identification	Identifies the drive unit
965	Profile Identification	Identifies the PROFIdrive profile version
974	Parameter Access Identification	Parameter channel request lengths
975	Drive Object Identification	Identifies the drive object
978	List of all DO-IDs	Returns a list of all axis IDs

11.14 Identification and Maintenance Functions

Identification and Maintenance (I&M) functions assist the user in tracking the drive's life cycle through Commissioning/start-up, parameterization, diagnosis, repair, etc. SM-PROFIBUS DP-V1 supports the following I&M functions:

- I&M0 (Read Only)
- I&M1 (Read/Write)
- I&M2 (Read/Write)
- I&M3 (Read/Write)
- I&M4 (Read/Write)

All I&M functions are available from masters which support this feature.

NOTE When the network compatibility mode is used (Pr **MM.41** = 1 or 2), DP-V1 functionality and the PROFIdrive (V4) profiles will not be available.

12 Advanced features

12.1 Network loss trip

Table 12.1 Network loss trip time-out

Pr MM.07	Default	200 (ms)
	Range	0 to 3000 (ms)
	Access	RW

The network loss trip provides a method on the drive to ensure that communication with the master is still present. The SM-PROFIBUS DP-V1 resets an internal timer when a valid message is received from the PROFIBUS-DP network, if a message is not received within the specified period the network loss trip is triggered. If the trip is generated by SM-PROFIBUS DP-V1, the trip display on the drive will be 'SLx.Er', where 'x' is the slot number where the trip originated. The SM-PROFIBUS DP-V1 error code parameter (Pr **MM.50**) will show 65 when a network loss trip has occurred.

NOTE The network loss trip is not enabled internally until cyclic data has been detected. This prevents spurious network loss trips while the PROFIBUS-DP master controller is initialising the PROFIBUS-DP network.

Figure 12-1 Network Loss Trip

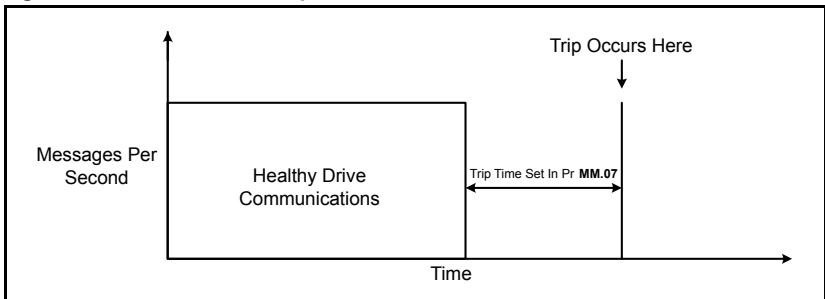

If the network loss trip time is reduced too far, spurious network loss trips may occur due to a time-out occurring before the next message has chance to arrive. The network loss trip time should be set such that a minimum of four messages will be received in the specified time period under normal operating conditions.



The network loss trip can be disabled by setting Pr **MM.07** to 0. It is the user's responsibility to ensure that adequate safety precautions are taken to prevent damage or injury by disabling the drive in the event of a loss of communications.

Safety Information
Introduction
Mechanical Installation
Electrical Installation
Getting started
Files
Cyclic data
Non-cyclic data
Control and status words
Diagnostics
PROFIBUS profile (V4)
Advanced features
Legacy features
Quick reference
Glossary of terms
Index

12.2 SYNC and FREEZE Mode

The SM-PROFIBUS DP-V1 supports the SYNC and FREEZE modes available with most PROFIBUS-DP master controllers.

Cyclic data is put into groups by the PLC allowing multiple cyclic channels to be suspended and updated using the SYNC and FREEZE commands. Data to the drive is controlled by the SYNC command and data from the drive controlled by the FREEZE command. The SYNC command is used in conjunction with the UNSYNC command and the FREEZE command is used in conjunction with the UNFREEZE command.

The SYNC command will cause a single transfer of the previously grouped data and stop any more data from being received by the drive. The SYNC command may be repeated while in this state to allow another single transfer of data to the drive. Issuing an UNSYNC command will revert the drive to continuous cyclic update of the received data.

The FREEZE command will cause a single transfer of the previously grouped data and stop any more data from being transmitted by the drive. The FREEZE command may be repeated while in this state to allow another single transfer of data from the drive.

Issuing an UNFREEZE command will revert the drive to continuous cyclic update of the transmitted data.

12.3 Data endian format

Table 12.2 Data endian format

Pr MM.08	Default	OFF
	Range	OFF (0) or ON (1)
	Access	RW

When data is sent over the PROFIBUS-DP network it is transmitted as 8-bit bytes.

Therefore when a 32-bit word or 16-bit word is transmitted it is split into four or two 8-bit bytes. It is important that the receiving node reconstructs the received 8-bit bytes in the correct order to arrive at the 32-bit or 16-bit data value that was originally transmitted, this order is known as the Data Endian Format and is shown in Table 12.3.

Table 12.3 Data endian format

Data endian format	Pr MM.08	16-bit value	32-bit value	
		Byte order	Word order	Byte order
Big	0	High byte first Low byte second	High word first Low word second	High byte first Mid-high byte second Mid-low byte third Low byte fourth
Little	1	Low byte first High byte second	Low word first High word second	Low byte first Mid-low byte second Mid-high byte third High byte fourth

Most PROFIBUS-DP master controllers use big endian format by default, many also support little endian, however some older PLCs do not offer the facility to select big endian format.

12.4 Inter-option communication timing

When more than one Solutions Module is installed to a drive (not Commander SK), communications between modules uses inter-option communications. Inter-option communications is slower than the communications directly to the drive parameters.

Typical access times for direct drive menu access will be in the region of 30µs (per parameter), a similar access using inter-option communications will be in the region of 1ms (per parameter).

When using inter-option communications, if parameters are sequential (within the same menu) then up to six parameters may be grouped in to a block, this will take up to 1ms for this block to be transferred. A total of eight blocks for input and eight blocks for output are available.

12.5 Cyclic data compression

Table 12.4 Cyclic data compression enable

Pr MM.34	Default	OFF (0)
	Range	OFF (0) or ON (1)
	Access	RW

By default, the SM-PROFIBUS DP-V1 uses 32 bits for each data channel, even if the target parameter in the drive is a 16-bit parameter. This strategy (known as casting) ensures that the cyclic data transmitted over the PROFIBUS-DP network is kept aligned with memory locations in 32-bit PLCs. When cyclic data compression is enabled (**MM.34** = ON) a data channel will only use 32 bits if the target drive parameter is a 32-bit parameter. If the target drive parameter is only 1, 8 or 16 bits wide 16 bits will be used for that particular data channel. This is shown in Table 12.5.

Table 12.5 Actual data sizes

Parameter Size (bits)	Actual Data Size (bits) Compression on	Actual Data Size (bits) Compression off
1	16	32
8	16	32
16	16	32
32	32	32

The following examples demonstrate setting up a network using five cyclic channels for both IN and OUT data with the cyclic data compression first disabled and then enabled.

Table 12.6 shows the mapping parameters where five IN and five OUT cyclic data channels are required. With data compression disabled each data channel uses 32 bits (two data words, so a total of ten words are required, Pr **MM.05** = 10).

Table 12.6 Example cyclic data channel mapping with compression off

Data channel	Data words used	Mapping for slot 3	Setting	Data width (bits)	Mapping status
IN channel 0	IN word 0, 1	Pr 17.10	1040	16	Pr 10.40, status word
IN channel 1	IN word 2, 3	Pr 17.11	201	32	Pr 2.01, post-ramp speed ref
IN channel 2	IN word 4, 5	Pr 17.12	420	16	Pr 4.20, motor load as% of rated motor load
IN channel 3	IN word 6, 7	Pr 17.13	1421	16	Pr 14.21, PID feedback
IN channel 4	IN word 8, 9	Pr 17.14	1401	16	Pr 14.01, PID output
OUT channel 0	OUT word 0, 1	Pr 17.20	642	16	Pr 6.42, control word
OUT channel 1	OUT word 2, 3	Pr 17.21	121	32	Pr 1.21, digital speed ref 1
OUT channel 2	OUT word 4, 5	Pr 17.22	211	32	Pr 2.11, acceleration ramp
OUT channel 3	OUT word 6, 7	Pr 17.23	221	32	Pr 2.21, deceleration ramp
OUT channel 4	OUT word 8, 9	Pr 17.24	1420	16	Pr 14.20, PID reference

It is advisable to keep 16-bit parameters paired together. This prevents mis-alignment of cyclic data with 32-bit PLC registers when using auto-mapping facilities to configure the PROFIBUS-DP network. By swapping the mappings for input channel 1 with input channel 2 and moving output channel 4 to output channel 1, the data channel structure will appear as shown in Table 12.7.

Table 12.7 Compressed cyclic data channel mapping

Data channel	Data words used	Mapping for slot 3	Setting	Data width (bits)	Mapping status
IN channel 0	IN word 0	Pr 17.10	1040	16	Pr 10.40, status word
IN channel 1	IN word 1	Pr 17.11	420	16	Pr 4.20, motor load as% of rated motor load
IN channel 2	IN word 2, 3	Pr 17.12	201	32	Pr 2.01, post-ramp speed ref
IN channel 3	IN word 4	Pr 17.13	1421	16	Pr 14.21, PID feedback
IN channel 4	IN word 5	Pr 17.14	1401	16	Pr 14.01, PID output
OUT channel 0	OUT word 0	Pr 17.20	642	16	Pr 6.42, control word
OUT channel 1	OUT word 1	Pr 17.21	1420	16	Pr 14.20, PID reference
OUT channel 2	OUT word 2, 3	Pr 17.22	121	32	Pr 1.21, digital speed ref 1
OUT channel 3	OUT word 4, 5	Pr 17.23	211	32	Pr 2.11, acceleration ramp
OUT channel 4	OUT word 6, 7	Pr 17.24	221	32	Pr 2.21, deceleration ramp

12.6 Block mapping

On SM-PROFIBUS DP-V1 there are ten mapping parameters available for both input and output mappings. If more than ten mappings are required then block mapping must be used to achieve this. Block mapping is configured by placing ascending parameters (within the same menu) into consecutive mapping parameters. Consider the example in Table 12.8.

NOTE Block mapping is only available when using Pr 18.xx, Pr 19.xx, Pr 20.xx and on the PLC registers within SM-Applications.

Table 12.8 Block Mapping Example

Mapping parameter	Mapping value	Description
Pr MM.10	2021	Map to 2021 as the start for the block mapping.
Pr MM.11	2026	Map to 2026 as the end for the block mapping.
Pr MM.20	2028	Map to 2028 as the start for the block mapping.
Pr MM.21	2031	Map to 2031 as the end for the block mapping.

This will map parameters Pr **20.21** to Pr **20.26** and Pr **20.28** to Pr **20.31** giving a total of ten mappings, using only four of the mapping parameters as shown in Figure 12-2.

Figure 12-2 Block Mapping Expansions

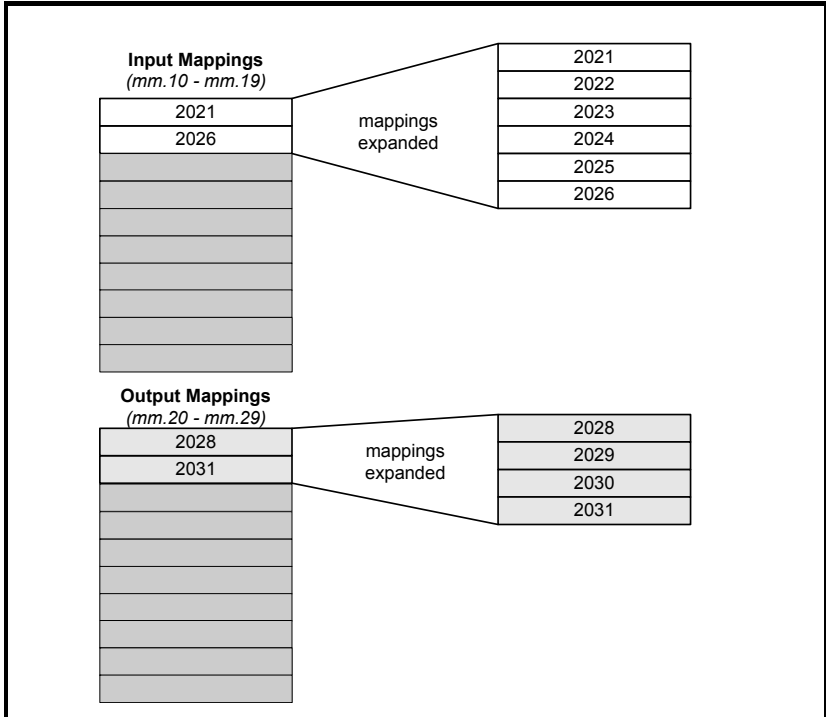

Using block mapping this can be extended to a maximum of 32 input and 32 output mappings when only cyclic data is used. If non-cyclic data is required in addition to cyclic data, this reduces to 31 words input and output for Mode 1 non-cyclic data and 28 words input and output for Mode 2 non-cyclic data.

Block mapping can also be used when mapping data to the PLC registers in an SM-Applications. If it is required to map to individual parameters within the same menu ensure that the target registers are listed in descending order (see section 12.6.1 *Avoiding block mapping*).

Safety Information
Introduction
Mechanical Installation
Electrical Installation
Getting started
GSD Files
Cyclic data
Non-cyclic data
Control and status words
Diagnostics
PROFIBUS profile (V4)
Advanced features
Legacy features
Quick reference
Glossary of terms
Index

12.6.1 Avoiding block mapping

In the above section block mapping was used to define mapping ranges. In order to avoid this the target parameters should be entered in descending order. This means that SM-PROFIBUS DP-V1 will not recognize a range of parameters and only two parameters will be mapped.

Table 12.9 Non-block data mapping example

Mapping parameter	Mapping value	Description
Pr MM.10	2004	Map to Pr 20.04.
Pr MM.11	2001	Map to Pr 20.01.
Pr MM.12 to Pr MM.19	0	Not mapped
Pr MM.20	2035	Map to Pr 20.35
Pr MM.21	2031	Map to Pr 20.31
Pr 17.22 to Pr 17.29	0	Not mapped

Table 12.10 Non-block data structure example

Data word	Target parameter	Data word	Target parameter
IN word 0, 1	Menu Pr 20.04	OUT word 0, 1	Pr 20.35
IN word 2, 3	Menu Pr 20.01	OUT word 2, 3	Pr 20.31
IN word 4-9	Not mapped	OUT word 4-9	Not mapped

12.7 Direct data mapping

Table 12.11 Direct data mapping enable

Pr MM.09	Default	OFF (0)
	Range	OFF (0) or ON (1)
	Access	RW

By default Pr **MM.10** to Pr **MM.29** are used as pointers to specify the source or destination parameters of the mappings. When direct data mapping is enabled Pr **MM.10** to Pr **MM.29** are used as the actual destination and source parameters for output and input data respectively.

If direct data mapping mode is enabled all mapping parameters (Pr **MM.10** to Pr **MM.29**) will be reset to 0. When data compression is OFF the number of data words specified in Pr **MM.05** must be an even number. If an odd number is specified the appropriate parameter will be set to specify the next lowest even number of data words (i.e. a value of 7 in Pr **MM.05** will only handle six data words or three data channels). This will not however, change the value in Pr **MM.05**.

NOTE Non-cyclic data cannot be used when direct data mapping mode is enabled.

Table 12.12 Direct data mapping configurations (data compression OFF)

Pr MM.05	Description
2 to 10	The first 10 IN channels will be written directly to Pr MM.10 to Pr MM.19 , and the first 10 OUT channels will be read directly from Pr MM.20 to Pr MM.29 .
100 to 109 200 to 206 300 to 309	Non-cyclic data cannot be used in direct data mapping mode. The SM-PROFIBUS DP-V1 operating status parameter (Pr MM.49) will indicate -3, and mapping error code (Pr MM.50) will indicate 2.

NOTE With data compression turned off each direct mapping will use 32 bits (two channels of mappings) on the network. This will revert to 16-bit (one channel) when turned on. For 32-bit mappings a maximum of five IN and five OUT mappings may be used with data compression turned on.

Parameters Pr **MM.10** to Pr **MM.29** are all 16-bit parameters, each data channel will be reduced to 16 bits when data compression is enabled. Hence, a maximum of ten data words can be specified in Pr **MM.05** or Pr **MM.39** and Pr **MM.40**.

Table 12.13 Direct data mapping configurations (data compression ON)

Pr MM.05	Description
1 to 10	The first 10 OUT channels will be written directly to Pr MM.10 to Pr MM.19 , and the first 10 IN channels will be read directly from Pr MM.20 to Pr MM.29 .
100 to 109 200 to 206 300 to 3098	Non-cyclic data cannot be used in direct data mapping mode. The SM-PROFIBUS DP-V1 operating status parameter (Pr MM.49) will indicate the value -3, and mapping error code (Pr MM.50) will indicate the value 2.

12.8 Custom data formats

Table 12.14 IN cyclic words

Pr MM.39	Default	4
	Range	0 to 32
	Access	RW

Table 12.15 OUT cyclic words

Pr MM.40	Default	4
	Range	0 to 32
	Access	RW

If the number of cyclic words is specified using the data format parameter (Pr **MM.05**) the number of input and output cyclic words will be the same (See section 7.2 *Data formats*). Pr **MM.39** and Pr **MM.40** will always display the current number of input and output cyclic data words being used.

When the data format (Pr **MM.05**) and the PPO Type (Pr **MM.38**) are both set to 0 the number of input data words can be specified in Pr **MM.39** and the number of output words in Pr **MM.40**. This allows different numbers of input and output cyclic data words to be specified.

CT Single Word or PPO 4 Word non-cyclic data can also be enabled by mapping input and output words to the appropriate source/destination parameter.

Table 12.16 Customized non-cyclic channel mapping

Source/destination parameter	Non-cyclic mode	Description
Pr 61.50	Mode 1 -CT Single Word	one IN and one OUT word must be assigned for use as the CT Single Word non-cyclic channel.
Pr 61.51	Mode 2 - PPO 4 Word	four IN and four OUT words must be assigned for use as the PPO 4 Word non-cyclic channel.

12.9 Restore defaults

Table 12.17 Restore defaults

Pr MM.30	Default	OFF (0)
	Range	OFF (0) or ON (1)
	Access	RW

If the host drive is defaulted (see the drive user guide for details) it will also clear the current configuration for the slot SM-PROFIBUS DP-V1 is installed to. Setting Pr **MM.30** to 1 additionally clears the backup copy of the SM-PROFIBUS DP-V1 configuration stored in the module.

This can be performed as follows:

- Set Pr **MM.30** to 1.
- Load drive default parameters (refer to relevant drive documentation for more information).
- PROFIBUS-DP communications will be stopped.
- The host drive will load and store its default parameter values.
- Default parameter values for the SM-PROFIBUS DP-V1 will be loaded.
- SM-PROFIBUS DP-V1 default parameter values will be stored in the backup copy in SM-PROFIBUS DP-V1 flash memory.
- The SM-PROFIBUS DP-V1 will reset and re-initialise using the default values.

12.10 Storing SM-PROFIBUS DP-V1 parameters (backup)

Table 12.18 Store to SM-PROFIBUS DP-V1 flash memory

Pr MM.31	Default	OFF
	Range	OFF (0) to ON (1)
	Access	RW

Option slot parameters are stored in the host drive memory and SM-PROFIBUS DP-V1 will always use these values during initialisation to configure itself. If a new SM-PROFIBUS DP-V1 is installed to the same slot it will communicate using the same settings as the previous SM-PROFIBUS DP-V1.

Using Pr **MM.31** it is possible to store the parameter configuration as a backup copy in the SM-PROFIBUS DP-V1 module. This allows the module to contain a backup copy of its configuration that may be restored using Pr **MM.33** (See section 12.11 *Restore previous SM-PROFIBUS DP-V1 configuration*). This is of particular use when setting up a module to send to site as a replacement or as a method of keeping a backup copy of the SM-PROFIBUS DP-V1 settings that may be used in the event of a drive failure.

NOTE If the stored values in the drive are for a different type of Solutions Module, the drive will trip with a slot error. The slot configuration parameters will be set to default values for SM-PROFIBUS DP-V1, but the default values will NOT be stored in the drive.

To store SM-PROFIBUS DP-V1 parameters in the SM-PROFIBUS DP-V1 backup flash memory:

- Set Pr **MM.31** to 1.
- Save drive parameters (refer to relevant drive documentation for more information).

The drive will perform a drive save and copy the settings from the slot menu associated with the SM-PROFIBUS DP-V1 into the SM-PROFIBUS DP-V1 local flash memory.

NOTE Drive parameters are NOT stored in the SM-PROFIBUS DP-V1.

12.11 Restore previous SM-PROFIBUS DP-V1 configuration

Table 12.19 Upload from SM-PROFIBUS DP-V1 flash memory

Pr MM.33	Default	OFF (0)
	Range	OFF (0) or ON (1)
	Access	RW

If valid configuration parameters have previously been stored in SM-PROFIBUS DP-V1 flash memory these values can be restored to the host drive parameters settings of the SM-PROFIBUS DP-V1. When the configuration parameter values have been uploaded to the host drive the SM-PROFIBUS DP-V1 will reset and re-configure using the updated parameter values. This feature allows a pre-configured SM-PROFIBUS DP-V1 to be installed to a host drive without losing the SM-PROFIBUS DP-V1 configuration.

NOTE If the SM-PROFIBUS DP-V1 is unable to upload the configuration parameters to the host drive or configuration parameters have never been stored in the SM-PROFIBUS DP-V1 flash memory, the drive will trip with a slot error and set the error code (Pr **MM.49**) to 70.

When Pr **MM.33** is set to ON the SM-PROFIBUS DP-V1 will transfer the configuration parameters from its flash memory to the host drive over-writing the existing values in the host drive.

The full sequence of events for restoring values from a SM-PROFIBUS DP-V1 installed in slot **MM** is as follows:

- Set Pr **MM.33** to ON.
- PROFIBUS-DP communications will be stopped.
- The SM-PROFIBUS DP-V1 will overwrite all Pr **MM.PP** parameters with the values stored in its internal flash memory.
- Pr **MM.33** will be reset to OFF.
- The SM-PROFIBUS DP-V1 will reset and re-initialise using the restored values.

NOTE This procedure will **NOT** store the updated host drive parameters and a drive save will be required to update the drive memory. If a drive save is not done, then this will result in SM-PROFIBUS DP-V1 resorting to previously stored parameters in the drive flash memory on the next power-up.

NOTE The SM-PROFIBUS DP-V1 will restore its configuration parameters to the menu of parameters associated with the slot that it is installed in. If an SM-PROFIBUS DP-V1 is moved from a slot on a drive it can be re-installed in any slot on another drive and will pass its configuration to the drive.

12.12 Menu 60 - Local Solutions access

Menu 60 provides a method of allowing a PROFIBUS-DP master to adjust parameters on the SM-PROFIBUS DP-V1 module independently of the slot number the module is installed to. The SM-PROFIBUS DP-V1 node is accessed using its PROFIBUS-DP address in conjunction with menu 60.

To change a parameter on SM-PROFIBUS a non-cyclic message should be sent to the node using menu 60 as the destination.

Table 12.20 Local slot configuration parameter access

Parameter	SM-PROFIBUS DP-V1 in slot 1*	SM-PROFIBUS DP-V1 in slot 2	SM-PROFIBUS DP-V1 in slot 3
Pr 60.01 - Pr 60.51	Pr 15.01 - Pr 15.51	Pr 16.01 - Pr 16.51	Pr 17.01 - Pr 17.51

* Commander SK only



Menu 60 parameters are only accessible from the PROFIBUS-DP network using non-cyclic data access methods. For more details see section 8.1 *What is non-cyclic data?*

12.13 Mapping to SM-Applications parameters

SM-PROFIBUS DP-V1 can read and write data directly to and from internal registers in an SM-Applications module. The mapping parameters are shown in Table 12.21.

Table 12.21 SM-Applications parameters

SM-Applications parameters	Lowest SM-Application Slot	Direct to slot 1	Direct to slot 2	Direct to slot 3
_Pxx% PLC Registers	Pr 70.xx	Pr 100.xx	Pr 130.xx	Pr 160.xx
_Qxx% PLC Registers	Pr 71.xx	Pr 101.xx	Pr 131.xx	Pr 161.xx
_Rxx% PLC Registers	Pr 72.xx	Pr 102.xx	Pr 132.xx	Pr 162.xx
_Sxx% PLC Registers	Pr 73.xx	Pr 103.xx	Pr 133.xx	Pr 163.xx
_Txx% PLC Registers	Pr 74.xx	Pr 104.xx	Pr 134.xx	Pr 164.xx
_Uxx% PLC Registers	Pr 75.xx	Pr 105.xx	Pr 135.xx	Pr 165.xx
Local Configuration Parameters	Pr 81.xx	Pr 111.xx	Pr 141.xx	Pr 171.xx
Timer Function Parameters	Pr 85.xx	Pr 115.xx	Pr 145.xx	Pr 175.xx
Digital I/O Parameters	Pr 86.xx	Pr 116.xx	Pr 146.xx	Pr 176.xx
Status Parameters	Pr 88.xx	Pr 118.xx	Pr 148.xx	Pr 178.xx
General Parameters	Pr 90.xx	Pr 120.xx	Pr 150.xx	Pr 180.xx
Fast Access Parameters	Pr 91.xx	Pr 121.xx	Pr 151.xx	Pr 181.xx

If the SM-PROFIBUS DP-V1 is configured to map data to Pr 70.xx to Pr 91.xx parameters data will be exchanged with the SM-Applications module installed in the lowest slot number. This method is convenient to use if there is only one SM-Applications module installed to the drive as it guarantees that data will always be written to and read from the SM-Applications module even if it is moved to a different slot. If, however, two or more SM-Applications modules are installed it is best to map directly to the required slot using the direct slot menu as shown in Table 12.21.

NOTE

Mapping to SM-Applications modules is not possible on drives with one option slot such as Commander SK.



If the number of mappings exceeds ten, block mapping should be used. See section 12.6 *Block mapping* on page 78.

12.13.1 Single SM-Applications installed

Consider a Unidrive SP with the following configuration:

- Slot 1 - Vacant
- Slot 2 - SM-Applications module.
- Slot 3 - SM-PROFIBUS DP-V1 module.

If a parameter read request comes over PROFIBUS-DP to read Pr **71.08** this will be redirected to the SM-Applications module in the lowest slot number (slot 2) and the value in `_Q08%` will be returned.

If a parameter read request comes over PROFIBUS-DP to read Pr **131.08**, this will be sent straight to the SM-Applications module in slot 2 and the value in `_Q08%` will be returned.

If a parameter read request comes over PROFIBUS-DP to read Pr **101.08**, this will be sent straight to the SM-Applications module in slot 1. As there is no SM-Applications module installed in slot 1 an error message will be returned indicating that the parameter does not exist.

12.13.2 Dual SM-Applications installed

Consider a Unidrive SP with the following configuration:

- Slot 1 - SM-Applications module.
- Slot 2 - SM-Applications module.
- Slot 3 - SM-PROFIBUS DP-V1 module.

If a parameter read request comes over PROFIBUS-DP to read Pr **71.08** this will be redirected to the SM-Applications module in the lowest slot number (slot 1) and the value in `_Q08%` will be returned.

If a parameter read request comes over PROFIBUS-DP to read Pr **131.08** this will be sent straight to the SM-Applications module in slot 2 and the value in `_Q08%` will be returned.

If a parameter read request comes over PROFIBUS-DP to read Pr **101.08** this will be sent straight to the SM-Applications module in slot 1 and the value in `_Q08%` will be returned.

NOTE This feature can only be used on drives that support multiple SM-Applications modules.

12.14 EVENT task trigger in SM-Applications

Table 12.22 SM-Applications EVENT task trigger

Slot			
Menu 15	Pr 61.41	Default	0
Menu 16	Pr 61.42	Range	0 to 4
Menu 17	Pr 61.43	Access	WO

The SM-Applications has four EVENT tasks available for use in DPL programs and the SM-PROFIBUS DP-V1 can be configured to trigger one of these tasks.

Safety information
Introduction
Mechanical installation
Electrical installation
Getting started
GSD Files
Cyclic data
Non-cyclic data
Control and status words
Diagnostics
PROFIDrive profile (V4)
Advanced features
Legacy features
Quick reference
Glossary of terms
Index

An EVENT task is triggered when the trigger parameter is actually written to and the value written (1 to 4) determines which task is actually triggered. The task trigger parameter can be written to using cyclic or non-cyclic data.

Table 12.23 EVENT task trigger parameters

Trigger parameter	Value written to trigger parameter				
	0	1	2	3	4
Pr 61.40*	No action	EVENT*	EVENT1*	EVENT2*	EVENT3*
Pr 61.41	No action	EVENT task in slot 1	EVENT1 task in slot 1	EVENT2 task in slot 1	EVENT3 task in slot 1
Pr 61.42	No action	EVENT task in slot 2	EVENT1 task in slot 2	EVENT2 task in slot 2	EVENT3 task in slot 2
Pr 61.43	No action	EVENT task in slot 3	EVENT1 task in slot 3	EVENT2 task in slot 3	EVENT3 task in slot 3

* The specified EVENT task will be triggered in the SM-Applications module installed in the lowest slot number on the drive.

When an EVENT task runs in the SM-Applications module the reason code parameter (Pr 90.12 to Pr 90.15 for EVENT to EVENT3 respectively) will indicate why the event task was triggered. The reason codes are given in Table 12.24. More information can be found in the *SM-Applications Modules and Motions Processors User Guide*.

Table 12.24 EVENT task reason codes

Solution Module	Reason code
SM-DeviceNet	1
SM-PROFIBUS DP-V1	2
SM-CANopen	3
SM-INTERBUS	4
SM-CAN	5

NOTE If cyclic data is used to trigger an EVENT task in an SM-Applications module it is best to map the last OUT cyclic data word to the EVENT task trigger parameter; as cyclic data is written to destination parameters in the order in which it is received, this guarantees that all received cyclic data will have been written to the target parameters BEFORE the EVENT task runs in the SM-Applications module.

NOTE This feature can only be used on drives with multiple option slots and that support the SM-Applications module.

12.15 Multi-master operation

The SM-PROFIBUS DP-V1 can be used on PROFIBUS-DP networks containing one or more master controllers. Consult your master controller documentation for information on how to configure a multi-master PROFIBUS-DP network.

NOTE Users must ensure that in networks with multiple master devices that only one master controller is configured to access the SM-PROFIBUS DP-V1.

NOTE SM-Profibus DP-V1 supports the simultaneous connection of one class 1 master and one class 2 master.

13 Legacy features

13.1 Network compatibility mode

Table 13.1 Network compatibility mode

Pr MM.41	Default	0 (SM-Profibus)
	Range	0 to 3
	Access	RW

A backwards compatibility mode has been added in SM-PROFIBUS DP-V1 firmware V03.01.00 and later. Pr **MM.41** can now be used to allow the SM-PROFIBUS DP-V1 module to appear as either a Unidrive Classic / Mentor II or a Commander SE, this only applies to the network and not the control/status words and parameter sizes. The module must be configured to match the existing network settings of the drive it is replacing (including any parameter mappings).

Table 13.2 Compatibility mode settings

Pr MM.41	Description
0	SM-Profibus DP (default)
1	Unidrive Classic / Mentor II
2	Commander SE
3	Extended diagnostics (using PROFIBUS ID 0x0B4F)

Using the compatibility mode allows the replacement of drives on a PROFIBUS-DP network, without having to make any changes to the master network configuration, it changes the identity code of the module so that the master believes that a similar type drive is present for a particular node.

When using the compatibility mode the drive can only act within the limitations of the drive it is simulating (i.e. four IN words and four OUT words).

NOTE When using compatibility mode, ensure that the correct GSD file for the simulated drive is being used and not the actual drive (Unidrive SP / Digitax ST / Mentor MP/ Affinity / Commander SK).

NOTE Depending on the application an SM-Applications module may be needed to account for any changes between the functionality of the two drives (i.e. any changes between the control and status words).



This mode only changes the network to emulate the Commander SE, Unidrive Classic or Mentor II on the network. Changes to the control method and data size differences must still be considered. This mode does **NOT** allow direct replacement.

When using extended diagnostics (Pr **MM.41** = 3), the appropriate GSD file using the correct PROFIBUS identification code (0x0B4F) must be used (e.g. 'SP__0B4F.GSD

For GSD file compatibility, please refer to Figure 6-1 *SM-PROFIBUS hardware and GSD file compatibility flowchart* on page 25.

NOTE When the network compatibility mode is used (Pr **MM.41** = 1 or 2), both the DP-V1 functionality and the PROFIdrive (V4) profiles will not be available.

13.2 PPO Types

SM-PROFIBUS DP-V1 supports all five types of Parameter Process data Object (PPO) defined by the PROFIdrive profile V2. The PROFIdrive profile features four specific functions which the SM-PROFIBUS DP-V1 translates into appropriate drive functions:

- PROFIdrive control word
- Main Setpoint
- PROFIdrive status word
- Main Actual Value

Each PPO mode uses a unique combination of features which are detailed in the following sections.

NOTE Do not confuse PPO 4 mode with Mode 2 - PPO 4 word non-cyclic data, they are not the same.

13.2.1 PPO 1

Table 13.3 PPO 1 mapping structure

IN Data	Function
word 0	Mode 2 non cyclic data (PPO 4-word)
word 1	
word 2	
word 3	
word 4	PROFIdrive status word
word 5	Main Actual Value

OUT Data	Function
word 0	Mode 2 non cyclic data (PPO 4-word)
word 1	
word 2	
word 3	
word 4	PROFIdrive control word
word 5	Main Setpoint

13.2.2 PPO 2

Table 13.4 PPO 2 mapping structure

IN Data	Function
word 0	Mode 2 non cyclic data (PPO 4-word)
word 1	
word 2	
word 3	
word 4	PROFIdrive status word
word 5	Main Actual Value
word 6	User configurable mapping using Pr MM.13 to Pr MM.16
word 7	
word 8	
word 9	

OUT Data	Function
word 0	Mode 2 non cyclic data (PPO 4-word)
word 1	
word 2	
word 3	
word 4	PROFIdrive control word
word 5	Main Setpoint
word 6	User configurable mapping using Pr MM.23 to Pr MM.26
word 7	
word 8	
word 9	

13.2.3 PPO 3

Table 13.5 PPO 3 mapping structure

IN Data	Function
word 0	PROFIdrive status word
word 1	Main Actual Value

OUT Data	Function
word 0	PROFIdrive control word
word 1	Main Setpoint

13.2.4 PPO 4

Table 13.6 PPO 4 mapping structure

IN Data	Function
word 0	PROFdrive status word
word 1	Main Actual Value
word 2	User configurable mapping using Pr MM.12 to Pr MM.15
word 3	
word 4	
word 5	

OUT Data	Function
word 0	PROFdrive control word
word 1	Main Setpoint
word 2	User configurable mapping using Pr MM.22 to Pr MM.25
word 3	
word 4	
word 5	

13.2.5 PPO 5

Table 13.7 PPO 5 mapping structure

IN Data	Function
word 0	Mode 2 non cyclic data (PPO 4-word)
word 1	
word 2	
word 3	
word 4	PROFdrive status word
word 5	Main Actual Value
word 6	User configurable mapping using Pr MM.13 to Pr MM.19
word 7	
word 8	
word 9	
word 10	
word 11	
word 12	
word 13	

OUT Data	Function
word 0	Mode 2 non cyclic data (PPO 4-word)
word 1	
word 2	
word 3	
word 4	PROFdrive control word
word 5	Main Setpoint
word 6	User configurable mapping using Pr MM.23 to Pr MM.29
word 7	
word 8	
word 9	
word 10	
word 11	
word 12	
word 13	

13.3 Configuring the Profile

To configure the profile to the required PPO mode use the following sequence:

- Set Pr **MM.05** to 0 to disable normal data format.
- Set Pr **MM.34** to ON to enable data compression.
- Set Pr **MM.38** to the required PPO type number (1 to 5).
- Configure the mapping parameters as required.
- Pr **MM.32** set to ON to re-initialise SM-PROFIBUS DP-V1.
- Check Pr **MM.06** is not a value of -3 (see section 10 *Diagnostics* on page 55 for further details).

Save the drive parameters (refer to relevant drive documentation for more information).

NOTE Pr **MM.32** will automatically reset to OFF when the process is complete.

NOTE Once the PROFdrive profile has been configured the corresponding mapping parameter will display a value of -1 and will be locked; only the user configurable mapping parameters will be editable.

If the PROFdrive profile has been configured after settings have already been made to the cyclic data mapping parameters, the first two or three mapping parameters (depending upon the PPO type chosen) will be over written and locked out.

13.4 PROFdrive control word

The PROFdrive control word consists of sixteen control bits some of which are reserved.

Table 13.8 PROFdrive control word bit functions

Bit	Value	Function	Description
0	1	ON	Ready; Voltage connected to the converter (i.e., main contactor on, if available); the drive goes into the switch-on inhibit status. The DC bus is charged; the drive is inhibited
	0	OFF1	Shutdown (returns to status not ready to switch on); ramps-down along the ramp-function generator ramp or along the DC bus voltage limit. At Speed=0 and Current=0, voltage is disconnected; main contactor off (if available).
1	1	Operating condition	All OFF 2 commands are withdrawn.
	0	OFF2	Voltage disconnected; inhibit the drive output stage. Main contactor is de-energized (if available), and the drive goes into the switch-on inhibit status: Motor coasts down
2	1	Operating condition	All OFF 3 commands are withdrawn.
	0	OFF3	Fast stop: If necessary, remove operating inhibit, fastest possible deceleration; at Speed=0 or Current=0, inhibit the drive and go to switch on inhibit state
3	1	Operation	Enable the drive and accelerate to the specified setpoint
	0	Inhibit operation	Inhibit the drive. Drive coasts down (ramp-function generator to zero or tracking), and into the ready status (refer to control word, bit 0).
4	1	Operating condition	---
	0	Inhibit ramp function generator	Ramp function generator output is set to zero. Main contactor remains in, the drive is not isolated from the supply, drive ramps down along the current limit or at the DC bus voltage limit.
5	1	Enable ramp function generator	---
	0	Stop ramp function generator	Freeze the current setpoint from the ramp function generator.
6	1	Enable Setpoint	Selected value at the ramp function generator input is switched in.
	0	Inhibit Setpoint	Selected value at the ramp function generator input is set to 0.
7	1	Acknowledge	Group signal is acknowledged at a positive edge; the drive is in the fault status until the fault has been removed and then goes into switch-on inhibit state.
	0	No meaning	
8	1	INCH1 ON	Prerequisite: Operation is enabled and Main Setpoint=0. The drive accelerates as fast as possible to inching Setpoint in the forward direction.
	0	INCH1 OFF	The drive brakes as fast as possible, if INCH1 was previously ON, and with Speed=0 and Current=0 goes into the status operation enabled.

Table 13.8 PROFdrive control word bit functions

Bit	Value	Function	Description
9	1	INCH2 ON	Prerequisite: Operation is enabled and Main Setpoint=0. The drive accelerates as fast as possible to inching Setpoint in the reverse direction.
	0	INCH2 OFF	The drive brakes as fast as possible, if INCH2 was previously ON, and with Speed=0 and Current=0 goes into the status operation enabled.
10	1	Network control	Control from the PROFIBUS-DP network, process (cyclic) data is valid.
	0	No control	Process data invalid. Last received valid process data values are retained.
11-15	0	Reserved	

13.5 PROFdrive status word

Table 13.9 gives the description of the function of each bit in the PROFdrive status word.

Table 13.9 PROFdrive status word bit functions

Bit	Value	Function	Description
0	1	Ready to switch on	Power supply switched on, the drive is inhibited.
	0	Not ready to switch on	---
1	1	Ready	Refer to Control word bit 0.
	0	Not ready	No action.
2	1	Operating condition	Refer to Control word bit 3.
	0	---	---
3	1	Fault	Drive faulted, and thus not operational, goes into the switch-on inhibit status after acknowledgment and the fault has been removed. Fault numbers in the fault parameter.
	0	Fault free	---
4	1	No OFF2	---
	0	OFF2	OFF2 command present.
5	1	No OFF3	---
	0	OFF3	OFF2 command Present.
6	1	Switch-on inhibit	Re-close only with OFF1 and then ON.
	0	No switch-on inhibit	---
7	1	Alarm	Not implemented
	0	No alarm	
8	0	Reserved	
9	1	Control requested	The automation system is requested to accept control.
	0	Local operation	Control only possible on the device itself.
10	1	Speed or Current reached	Actual value = comparison value (Setpoint), set via the parameter number.
	0	Below set Speed or Current	---
11-15	0	Reserved	

13.6 Main Setpoint

Main Setpoint is the speed reference defined in the PROFIdrive profile.

It is scaled such that -32768 to +32767 is -200% to +200% of the maximum speed clamp (Pr 1.06). The converted value is then written to drive digital speed reference 1 (Pr 1.21).

The formula used for this conversion is:

$$\text{Pr 1.21} = \frac{\text{Main Setpoint} \times \text{Max Speed Clamp}}{16384}$$

Example 1 - Open loop drive

The drive maximum speed clamp (Pr 1.06) = 50Hz, the main Setpoint value sent from the master to the drive is 13107

Giving:

$$\text{Pr 1.21} = \frac{13107 \times 50}{16384} = 40.0\text{Hz}$$

Example 2 - Closed loop / servo drive

The drive maximum speed clamp (Pr 1.06) = 1500 rpm, the main Setpoint sent from the master to the drive is 10923

Giving:

$$\text{Pr 1.21} = \frac{10923 \times 1500}{16384} = 1000\text{rpm}$$

13.7 Main Actual Value

Main Actual Value is the speed feedback reference defined in the PROFIdrive profile.

It is scaled such that -32768 to +32767 is -200% to +200% of the maximum speed clamp (Pr 1.06). The converted value is derived from:

- Pr 2.01 for open loop drive operation.
- Pr 3.02 closed loop or servo drive operating modes.

The formula used for this conversion is:

$$\text{Main Actual Value} = \frac{\text{SF} \times 16384}{\text{Max Speed Clamp}}$$

Where SF is the speed feedback parameter, i.e. Pr 2.01 or Pr 3.02 depending upon the drive operating mode.

Example 1 - Open loop drive

The drive maximum speed clamp (Pr 1.06) = 50Hz

The drive post ramp reference (Pr 2.01) = 35 Hz

Giving:

$$\text{MAV} = \frac{35 \times 16384}{50} = 11469$$

Example 2 - Closed loop / servo drive

The drive maximum speed clamp (Pr 1.06) = 1500 rpm

The main Setpoint sent from the master to the drive is 10923

Giving:

$$\text{MAV} = \frac{1250 \times 16384}{3000} = 1000\text{rpm}$$

13.8 PROFIdrive (V2) state machine diagram

The following pages contain the state machine diagram and state descriptions for the legacy PROFIdrive profile V2 control and status words. Figure 13-1 shows how the current, next and previous states are determined.

Refer to section 13.4 *PROFIdrive control word* on page 90 and section 13.5 *PROFIdrive status word* on page 91 for full details about the PROFIdrive control and status words.

NOTE

This section is included for information on the superseded PROFIdrive profile V2, new installations should use the PROFIdrive profile V4 described in section 11 *PROFIdrive profile (V4)* on page 63.

Safety Information
Introduction
Mechanical Installation
Electrical Installation
Getting started
GSD Files
Cyclic data
Non-cyclic data
Control and status words
Diagnostics
PROFIdrive profile (V4)
Advanced features
Legacy features
Quick reference
Glossary of terms
Index

Figure 13-1 PROFIdrive (V2) State Machine Diagram

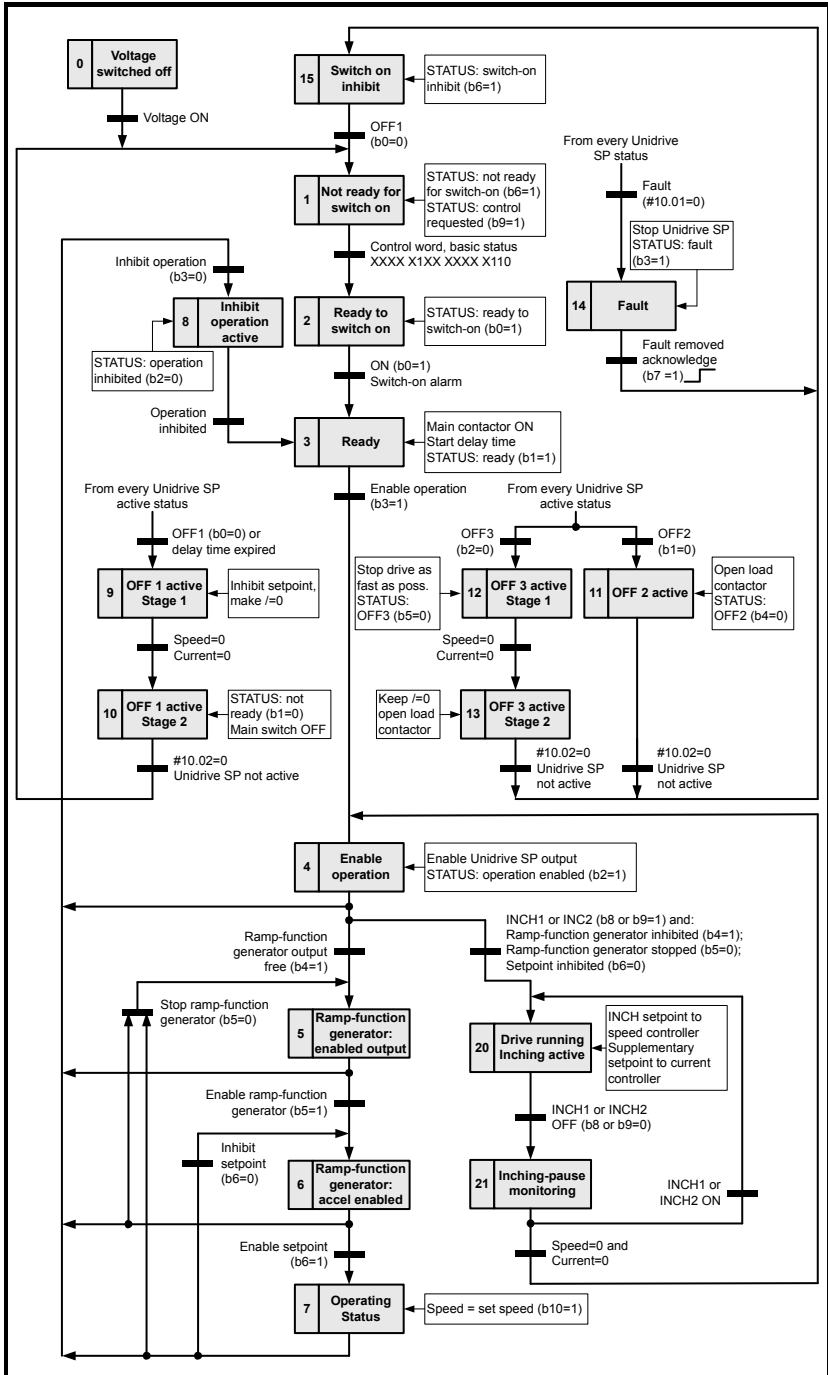

Table 13.10 PROFIdrive (V2) State Machine Control States In Detail

State	Title	Control word update (Pr 6.42)	Other actions
0	Voltage switched off	None	Supply voltage disconnected
1	Not ready for switch on	None	Supply voltage connected, drive is inhibited
2	Ready to switch on	AUTO set to 1 All other bits reset to 0	Pr 6.43 set to 1
3	Ready	ENABLE, JOG and RUN reset to 0	Read and cache Pr 1.06 for speed reference calculations
4	Enable operation	ENABLE set to 1 JOG and RUN reset to 0	Select STOP RAMP mode (Set Pr 6.01=1) Set preset ref 1 to 0 (Set Pr 1.21=0) Select preset ref (Set Pr 1.14=3) Select preset ref 1 (Set Pr 1.15=1) Disable ramps (Set Pr 2.02=0)
5	Ramp-function generator enabled output	ENABLE and RUN set to 1	Set preset ref 1 to 0 (Set Pr 1.21=0) Enable ramps (Set Pr 2.02=1)
6	Ramp-function generator acceleration enabled	ENABLE and RUN set to 1	Set preset ref 1 to 0 (Set Pr 1.21=0) Set Ramp Hold (Set Pr 2.03=1)
7	Operating status	ENABLE and RUN set to 1	Convert MAIN SETPOINT to Hz or rpm and set Pr 1.21 Release ramp hold (Set Pr 2.03=0)
8	Inhibit operation active	ENABLE, JOG and RUN reset to 0	Select STOP RAMP mode (Set Pr 6.01=1)
9	OFF 1 active stage 1	ENABLE set to 1 JOG and RUN reset to 0	Select STOP RAMP mode (Set Pr 6.01=1)
10	OFF 1 active stage 2	ENABLE reset to 0	None
11	OFF 2 active	ENABLE reset to 0	Select COAST mode (Set Pr 6.01=0)
12	OFF 3 active stage 1	ENABLE set to 1 JOG and RUN reset to 0	Select RAMP WITH DC INJECTION mode (Set Pr 6.01=2)
13	OFF 3 active stage 2	ENABLE reset to 0	None
14	Fault	JOG and RUN reset to 0	Select STOP RAMP mode (Set Pr 6.01=1) Set RESET to 1 when ACK bit is set to 1
15	Switch on inhibit	No change	None
20	Drive running, inching active	JOG and RUN set to 1 FWD REV is set to 1 if INCH2 (b9) is set to 1, reset to 0 if INCH1 (b8) is set to 1	None
21	Inching-pause monitoring	JOG, FWD REV and RUN reset to 0	None

Safety information
Introduction
Mechanical installation
Electrical installation
Getting started
GSD files
Cyclic data
Non-cyclic data
Control and status words
Diagnostics
PROFIdrive profile (V4)
Advanced features
Legacy features
Quick reference
Glossary of terms
Index

14 Quick reference

14.1 Complete parameter reference

Table 14.1 lists all the SM-PROFIBUS DP-V1 set-up parameters that are required to configure the module.

Table 14.1 SM-PROFIBUS DP-V1 parameter reference

Menu	Default	Cross reference	Description
Pr MM.01	403	Section 10-1 on page 62	Module ID code.
Pr MM.02	----	Section 10.2 on page 55	Major firmware version.
Pr MM.03	126	Section 5.4 on page 18	Node address.
Pr MM.04	----	Section 5.5 on page 18	Data rate.
Pr MM.05	4	Section 7.2 on page 26	Data format.
Pr MM.06	----	Section 10.6 on page 57	Operating status.
Pr MM.07	200	Section 12.1 on page 75	Network loss trip time-out.
Pr MM.08	Big (0)	Section 12.3 on page 76	Endian format select.
Pr MM.09	OFF (0)	Section 12.7 on page 80	Direct data mapping enable
Pr MM.10	1040	Section 7.2 on page 26	IN cyclic mapping 0.
Pr MM.11	201		IN cyclic mapping 1.
Pr MM.12	0		IN cyclic mapping 2.
Pr MM.13	0		IN cyclic mapping 3.
Pr MM.14	0		IN cyclic mapping 4.
Pr MM.15	0		IN cyclic mapping 5.
Pr MM.16	0		IN cyclic mapping 6.
Pr MM.17	0		IN cyclic mapping 7.
Pr MM.18	0		IN cyclic mapping 8.
Pr MM.19	0		IN cyclic mapping 9.
Pr MM.20	642	Section 7.2 on page 26	OUT cyclic mapping 0.
Pr MM.21	121		OUT cyclic mapping 1.
Pr MM.22	0		OUT cyclic mapping 2.
Pr MM.23	0		OUT cyclic mapping 3.
Pr MM.24	0		OUT cyclic mapping 4.
Pr MM.25	0		OUT cyclic mapping 5.
Pr MM.26	0		OUT cyclic mapping 6.
Pr MM.27	0		OUT cyclic mapping 7.
Pr MM.28	0		OUT cyclic mapping 8.
Pr MM.29	0		OUT cyclic mapping 9.
Pr MM.30	0	Section 12.9 on page 82	Restore SM-PROFIBUS DP-V1 defaults.
Pr MM.31	0	Section on page 82	Store to SM-PROFIBUS DP-V1 flash memory.

Table 14.1 SM-PROFIBUS DP-V1 parameter reference

Menu	Default	Cross reference	Description
Pr MM.32	0	Section 5.8 on page 20	Re-initialize SM-PROFIBUS DP-V1. This will automatically change back to 0 after re-initialisation.
Pr MM.33	0	Section 12.11 on page 83	Restore the previous parameter configuration from SM-PROFIBUS DP-V1 flash memory.
Pr MM.34	0	Section 12.5 on page 77	Cyclic data compression enable.
Pr MM.35	----	Section 10.10 on page 61	Serial Number.
Pr MM.38	0	Section 13.2 on page 88	PPO selected.
Pr MM.39	4	Section 12.8 on page 81	IN cyclic data words.
Pr MM.40	4		OUT cyclic data words.
Pr MM.41	0	Section 13.1 on page 87	SM-PROFIBUS DP-V1 Network compatibility mode
Pr MM.49	----	Section 10.7 on page 58	Mapping status.
Pr MM.50	----	Section 10.9 on page 60	SM-PROFIBUS DP-V1 error codes.
Pr MM.51	----	Section 10.2 on page 55	Minor firmware version.

Table 14.2 SM-PROFIBUS DP-V1 virtual parameter reference

Parameter	Default	Cross reference	Description
Pr 61.01	----	----	Parameter Pr 01.00 shortcut.
Pr 61.20*	----	----	Coarse and turns position feedback.
Pr 61.21*	----	----	Turns and fine position feedback.
Pr 61.35	----	Section 10.10 on page 61	Serial number.
Pr 61.40*	0	Section 12.14 on page 85	SM-Applications event task trigger (lowest slot).
Pr 61.41*	0		SM-Applications event task trigger (slot 1).
Pr 61.42*	0		SM-Applications event task trigger (slot 2).
Pr 61.43*	0		SM-Applications event task trigger (slot 3).
Pr 61.50	0	Section 8.6 on page 34	CT single word (Mode 1) non-cyclic data mapping parameter.
Pr 61.51	0	Section 8.8 on page 44	PPO 4 Word (Mode 2) non-cyclic data mapping parameter.

* Not applicable to Commander SK.

NOTE Some drive firmware versions will hide unused or reserved parameters.

Safety information
Introduction
Mechanical installation
Electrical installation
Getting started
GSD files
Cyclic data
Non-cyclic data
Control and status words
Diagnostics
PROdrive profile (V4)
Advanced features
Legacy features
Quick reference
Glossary of terms
Index

14.2 Operating status codes

Table 14.3 PROFIBUS-DP operating status codes

Pr MM.06	Parameter	Description
>0	Network ok	Indicates the number of processed cyclic messages per second.
0	Network ok, No Data Transfer	Indicates that the PROFIBUS-DP master has established communications with the SM-PROFIBUS DP-V1. If operating status changes briefly to -1 and returns to 0, the slave configuration does not match the configuration in the master controller.
-1	Initialised	Indicates that the SM-PROFIBUS DP-V1 has initialized correctly, and is waiting for the PROFIBUS-DP master to initialize communications.
-2	Internal Hardware Failure	Indicates that part of the SM-PROFIBUS DP-V1 initialisation sequence was not successful. If this fault persists after a power cycle, replace the SM-PROFIBUS DP-V1 module.
-3	Configuration Error	Indicates that there is an invalid setting in the configuration parameters of the SM-PROFIBUS DP-V1 module.

14.3 Mapping error codes

Table 14.4 Mapping error codes

Mapping status	Error	Description
0	No error detected	No error detected with IN or OUT cyclic data mapping configuration.
2	Direct data mapping error	Non-cyclic data cannot be used when direct data mapping is enabled.
3	Invalid non-cyclic mode	An invalid non-cyclic data mode has been set in Pr MM.05 .
5	Invalid mode value	The value entered in Pr MM.05 is not supported.
30	Configuration error	After expanding ranges of block mappings, too many OUT cyclic data channels configured.
31	PPO error	Direct data mapping cannot be selected when using a PPO mode.
32	PPO and data format error	Data format cannot be specified when using a PPO mode.
33	Data compression disabled with PPO	Data compression must be ON when using a PPO mode.
104	Multiple non-cyclic mapping error	A non-cyclic data mode has been mapped more than once in the IN data mapping configuration parameters (Pr MM.10 to Pr MM.19).
110	Configuration read error	An error has occurred reading the IN cyclic data mapping configuration parameters (Pr MM.10 to Pr MM.19) from the drive.
111	Invalid source parameter	One or more parameters specified in the IN cyclic data mapping configuration (Pr MM.10 to Pr MM.19) is outside of the allowed range for SM-PROFIBUS DP-V1. The allowable parameter range is from Pr 0.00 to Pr 199.99 .
112	Read mismatch	One or more parameters specified in the IN cyclic data mapping configuration (Pr MM.10 to Pr MM.19) cannot be used as a source parameter for IN data. The parameter may not exist.
113	Hole in IN data mapping configuration	IN cyclic data mapping parameters (Pr MM.10 to Pr MM.19) are not contiguous. It is not possible to have an unused parameter in the middle of the cyclic data.
115	Inter-option communications error	A request to set up an inter-option communications block failed. Either the server does not support block transfer or parameters were not legal.

Table 14.4 Mapping error codes

Mapping status	Error	Description
120	Too many IN data objects mapped	After expanding ranges of block mappings, too many IN cyclic data channels configured.
121	Mapping over length	Total size of all IN cyclic data mappings has exceeded the total size of the cyclic data.
122	Register mode objects exceeded	More than ten cyclic IN data channels have been selected with direct data mapping mode.
204	Multiple non-cyclic mapping error	A non-cyclic data mode has been mapped more than once in the OUT cyclic data mapping configuration parameters (Pr MM.20 to Pr MM.29)
210	Configuration read error	An error has occurred reading the OUT cyclic data mapping configuration parameters (Pr MM.20 to Pr MM.29) from the drive.
211	Invalid destination parameter	One or more parameters specified in the OUT cyclic data mapping configuration (Pr MM.20 to Pr MM.29) is outside of the allowed range for PROFIBUS-DP. The allowable parameter range is from Pr 0.00 to Pr 199.99 .
212	Write mismatch	One or more parameters specified in the OUT cyclic data mapping configuration (Pr MM.20 to Pr MM.29) cannot be used as a destination parameter for OUT data. The parameter may not exist, or is a read-only parameter. This error will also occur if an attempt is made to map OUT data to the configuration parameters of a fieldbus option in another slot, unless that fieldbus is configured in register mode i.e. Pr MM.09 = ON (1).
213	Hole in OUT data mapping configuration	OUT data mapping parameters (Pr MM.20 to Pr MM.29) are not contiguous. It is not possible to have an unused parameter in the middle of the cyclic data.
214	Duplicate mapping error	Two or more OUT cyclic data mapping configuration parameters (Pr MM.20 to Pr MM.29) have been configured with the same destination parameter reference.
215	Inter-option communications error	A request to set up an inter-option communications block failed. Either the server does not support block transfer or parameters were not legal.
220	Too many OUT data objects mapped	After expanding ranges of block mappings, too many OUT cyclic data channels configured.
221	Mapping over length	Total size of all OUT cyclic data mappings has exceeded the total size of the cyclic data.
222	Register mode objects exceeded	More than ten cyclic OUT data channels have been selected with direct data mapping mode.

Safety information
Introduction
Mechanical installation
Electrical installation
Getting started
GSD files
Cyclic data
Non-cyclic data
Control and status words
Diagnostics
PROFdrive profile (V4)
Advanced features
Legacy features
Quick reference
Glossary of terms
Index

14.4 Error codes

Table 14.5 SM-PROFIBUS DP-V1 error codes

Error code	Fault	Description
0	No error detected	Indicates that the SM-PROFIBUS DP-V1 module is ok. It is possible to trip the drive externally via various communication channels.
52	User control word trip	The TRIP bit has been set in the drive control word.
61	Configuration error	An invalid module configuration has been detected. Refer to Pr MM.49 for mapping error codes.
65	Network loss	No new messages have been received for the specified network loss trip time.
66	Critical link failure	Internal error
70	Flash transfer error	The SM-PROFIBUS DP-V1 was unable to upload the configuration parameters from its flash memory to the drive.
71	Invalid fieldbus specific data	SM-PROFIBUS DP-V1 has detected an invalid data record. E.g. the stored I&M data has an invalid checksum.
74	SM-PROFIBUS DP-V1 overtemperature	If the temperature inside the SM-PROFIBUS DP-V1 module exceeds 82°C, SM-PROFIBUS DP-V1 will trip the drive.
80	Inter-option communication error	An inter-option communication time-out has occurred, but SM-PROFIBUS DP-V1 is unable to determine the reason for the error.
81	Communication error to slot 1	Communications between the SM-PROFIBUS DP-V1 module and an SM-Applications module in another slot has timed out.
82	Communication error to slot 2	
83	Communication error to slot 3	
97	Firmware incompatible	The hardware revision level does not support the installed firmware version. If DP-V1 functionality is required then replace the module with a DP-V1 compatible module. If DP-V1 functionality is not required then install an earlier firmware version (03.01.01 or earlier).
98	Internal watchdog error	Internal error. Cycle power to the drive to reset from this trip.
99	Internal software error	Internal error. Cycle power to the drive to reset from this trip. If trip persists, replace the SM-PROFIBUS DP-V1.

15 Glossary of terms

Address: This is the unique network identification given to a networked device to allow communication on a network. When a device sends or receives data the address is used to determine the source and the destination of the message.

Bit: A binary digit, this may have the value of 1 or 0.

Block mapping: A method of mapping a range of consecutive parameters using only two ascending parameters. This means that by using two mapping parameters up to 32 consecutive mappings may be made. See section 12.6 *Block mapping* on page 78 for more information.

Byte: A collection of eight binary digits that collectively store a value. This may be signed or unsigned.

Casting: The process of changing between data sizes without changing the value represented, e.g. changing from 16-bit to 32-bit.

Compression: By default SM-PROFIBUS DP-V1 transmits values as 32 bits on the network. It is possible by using data compression to reduce the number of bits transmitted when sending 16-bit (or smaller) values on the network to 16-bit (32-bit values will still be transmitted as 32 bit values). This has the advantage of reducing the volume of traffic on the network and allowing more parameters to be mapped within the SM-PROFIBUS DP-V1.

Consistency: Describes how data is transmitted between nodes on the network. If data is consistent it is transmitted from node to node as a single entity. Thus preventing data corruption where multiple bytes are transmitted or received individually.

Control word: A collection of binary digits that are used to control the drive. Features typically include directional controls, run controls and other similar functions.

CT Single Word non-cyclic: see *Mode 1 non-cyclic in this section*.

Cyclic channel: An area of the Profibus-DP message frame used for cyclic communication to a single drive parameter.

Cyclic data: This consists of values that are sent at regular or cyclic intervals across the network. A typical use of cyclic data would be the transmission of a speed reference or a control word.

Data format: Determines the quantity and function of the network data.

Data rate: Determines the communication speed of the network, the higher the value the more data can be sent across the network in the same time period.

Device: A piece of equipment connected to a network, this may be any type of equipment including repeaters, hubs, masters or slaves.

Safety Information
Introduction
Mechanical Installation
Electrical Installation
Getting started
GSD Files
Cyclic data
Non-cyclic data
Diagnosics
PROFdrive profile (V4)
Advanced features
Legacy features
Quick reference
Glossary of terms
Index

Direct data mapping: Data is sent directly to the mapping parameters in the drive rather than the parameters redirecting the data to another parameter.

Double word: A 32-bit word, this may be signed or unsigned.

DPV 0,1,2: This describes the specification version of PROFIBUS-DP used.

Earthing: Describes the electrical safety or shielding connections for the module.

Endian format: When a value uses more than eight bits to represent its value it needs to be sent in sets of eight bits (bytes) across the network, the endian format determines the order the bytes that constitute the whole value are transmitted.

Event task: A way to use a message or change of state to trigger a software routine.

FREEZE: A method of preventing input state changes from being sent to the master, until a FREEZE signal is sent, this is used in conjunction with UNFREEZE.

Grounding: See Earthing

Groups: Groups are used with the SYNC and FREEZE commands. A group defines which nodes respond to a specific SYNC or FREEZE command.

GSD file: A file that defines the properties of a node. The file contains information describing the features available on the device.

IN data: Data that is returned from a slave device to the PROFIBUS master.

Long word: A 32-bit data word that may be signed or unsigned.

Network Loss Trip: A way to determine when a node has lost contact with the master.

Node: A device on the network. This may be either a device such as a drive or part of the network such as a repeater.

Non-Cyclic Data: Data that is requested or sent by the master as required. This is not sent on a regular basis and generally allows access to any parameter. This is useful for occasional changes or configuration purposes.

Main actual value: This gives feedback on the running speed of the drive when using the PROFIdrive profile.

Main Setpoint: The value used to determine the speed of the drive when using the PROFIdrive profile.

Mapping: The process of linking PROFIBUS values to parameters within the drive.

Master: The controlling device on the network, generally this will include programming features.

Mode 1 non-cyclic: A method of sending non-cyclic data using a single word.

Mode 2 non-cyclic: A method of sending non-cyclic data using four words.

PROFdrive profile: A standardized method of controlling drives that is independent of the manufacturer.

Poll rate: The rate at which cyclic data is sent and received on the network.

PPO Modes: Different operational modes within the PROFdrive profile. PPO 4 mode is not the same as Mode 2 - PPO 4 Word mode non-cyclic data.

PPO 4 Word non-cyclic mode: see Mode 2 non-cyclic in this section. This is not the same as PPO4 mode.

Response ID: The response code of the message received when using PPO4 word non-cyclic communication.

Scan rate: See Poll rate in this section.

Segment: An electrically separate part of the network. Each segment requires correct termination to ensure reliable operation. Due to electrical limitations the maximum number of devices on a segment is limited to 32.

Shielding: A connection to provide additional noise immunity on a network cable.

Slave: A device on the PROFIBUS network such as a drive or sensor. A slave device will only respond to messages from a master.

Status word: A value that denotes the status of the drive. Each bit within the word will have a specific meaning.

SYNC: A method of preventing output state changes from being actioned by the slave, until a SYNC signal is sent, this is used in conjunction with UNSYNC.

Task ID: The code used to describe the purpose of a message using PPO 4 word non-cyclic communication.

Telegram: A message used within Mode 1 non-cyclic data communication. This term is sometimes used to represent a generic message on the network.

Termination: This is used at both ends of a network segment to prevent reflections and reduce noise. On PROFIBUS, termination is provided by a powered network of resistors.

UNSYNC: Used to restore outputs in a slave to normal operation following a SYNC command.

UNFREEZE: Used to restore inputs in a slave to normal operation following a FREEZE command.

Watchdog: A method used to determine if a communication system is ok. A typical watchdog scheme uses a handshaking system to check both the master and slave are participating in communications.

Word: A collection of 16 binary digits.

Safety Information
Introduction
Mechanical Installation
Electrical Installation
Getting started
GSD Files
Cyclic data
Non-cyclic data
Diagnoses
PROFdrive profile (V4)
Advanced features
Legacy features
Quick reference
Glossary of terms
Index

Index

Numerics

16-bit parameter access	44
2 cyclic channels only	28
3 cyclic channels	28
5 cyclic channels	28
8 cyclic channels with PPO 4 word	29

A

Abort CT single word	43
Above set speed	53
Actual data sizes	77
At speed	53
Avoiding block mapping	80

B

Backup	82
Below set speed	53
Byte order	76

C

Cable	14
Cable shield connections	14
Cautions	6
Complete parameter reference	96
Compliance	7
Configuration error	19
Configuring the profile	88
Connections	13
Connectors	13
Consistency	23
Contents	3
Control word	51
Control word bit functions	52
CT single word protocol	35
Current limit	53
Custom data formats	81
Cyclic data	26, 76

D

Data compression	77
Data endian format	76
Data format	19, 57
Data mapping	19
Data mapping errors	29
Data rate	18, 56
Data rates	57
Device loading	15
Diagnostic flow chart	62
Diagnostics	55
Direct data mapping	80

Disabling cyclic data channels	30
Disabling mappings	30
DP-V1 Drive Identification	74
DP-V1 Fault Buffer	73
DP-V1 Identification and Maintenance Functions	74
DP-V1 Parameter Access	33
DP-V1 PROFIdrive PNU access	72
DP-V1 Standard Telegram 1	63
DP-V1 Standard Telegram 1 + 4 cyclic words	64
DP-V1 Standard Telegram 1 + 8 cyclic words	64
DP-V1 State Machine	66
Drive active	53
Drive Identification	74
D-type	13
D-Type connections	13
D-Type pin out	13
Dynamic brake active	54
E	
Electrical installation	13
Electrical safety	6
Endian format	76
Environmental limits	7
Error	58, 98
Error codes	100
Event task reason codes	86
Event task trigger	85
F	
Fault Buffer	73
Fault Buffer Associated PNUs	74
Firmware version	55
Formats	26
FREEZE	76
G	
Getting started	16
Glossary of terms	101
GSD	23
GSD compatibility	24
H	
Hardware enable	51
I	
ID code	55
Identification PNUs	74
Inter-option communication timing	77
J	
Jogging	69
L	
Local solutions access	84

Safety Information
Introduction
Mechanical Installation
Electrical Installation
Getting started
GSD Files
Cyclic data
Non-cyclic data
Control and status words
Diagnostics
PROFIdrive profile (V4)
Advanced features
Legacy features
Quick reference
Glossary of terms
Index

M

Mapping conflicts	29
Mapping error codes	98
Mapping errors	29
Mapping parameters	27
Mapping status	58
Mapping to SM-Applications	84
Menu 60	81, 84
Mode 1	23, 34
Mode 2	23, 44
Multi-master	86

N

Network compatibility mode	87
Network length	15
Network loss trip	75
Network termination	14
Node address	18, 56
Non-cyclic data	31
Non-cyclic mode	33
Normal Run Sequence	66

O

Operating status	19, 57
Operating status codes	19, 98
Overview	10

P

Parameter reference	96
Parameters - adjusting	7
PPO 1	88
PPO 2	88
PPO 3	64, 88
PPO 4	64, 89
PPO 4 word	23
PPO 4 word error codes	46
PPO 4 word mode	44
PPO 4 word read	47
PPO 4 word write	49
PPO 5	89
PPO types	63
Problems	55
PROFIBUS DP-V1 Compatibility	31
PROFIdrive (V2) State Machine	93
PROFIdrive (V4) State Machine	66
PROFIdrive control word	70
PROFIdrive control word bit functions	70
PROFIdrive PNU access	72
PROFIdrive profile	63
PROFIdrive status word	71, 91
PROFIdrive status word bit functions	71
PROFIdrive V4 General State Machine Diagram	67
PROFIdrive V4 Speed Control State Machine Diagram	68

Q	
Quick reference	96
R	
Reading parameters using CT Single Word	36
Reason codes	86
Regenerating	54
Re-initialise	20
Re-initialise all Solutions Modules	20
Response ID codes	46
Restore configuration	83
Restore defaults	82
Running at or below minimum speed	53
S	
Safety of personnel	6
Saving	20
SECURE DISABLE / SAFE TORQUE OFF	6
Serial number	61
Set-up flow chart	17
Single SM-Applications	85
Single word	23
Single word mode	34
Single word non-cyclic data	34
Solutions Module identification	11
Specification	10
Speed Control State Machine	68
Spurs	15
Standard Telegram 1	63
Status codes	19
Status word	53
Status word bit functions	53
Stopping the motor using PROFdrive	69
Storing parameters	82
Supported PROFdrive PNUMs	72
SYNC	76
T	
Task id codes	45
Task trigger	85
Telegrams	37
Terminal descriptions	13
Termination	14
Trip display codes	60
U	
UNFREEZE	76
Unidrive SP	10
Unidrive SP control word	51
UNSYNC	76
V	
V4.0 General State Machine Diagram	67
Virtual parameter reference	97

Safety information
Introduction
Mechanical installation
Electrical installation
Getting started
GSD Files
Cyclic data
Non-cyclic data
Control and status words
Diagnostics
PROFdrive profile (V4)
Advanced features
Legacy features
Quick reference
Glossary of terms
Index

W	
Warnings	6
Watchdog	103
Word order	76
Writing parameters using CT Single Word	40
Writing parameters using PPO 4 Word mode	49
Z	
Zero speed	53



0471-0008-10